

# User Manual

## MCS®





1	Introduction .....	5
1.1	Symbols used .....	5
1.2	Notations .....	5
2	Safety instructions.....	5
2.1	Intended use.....	5
2.2	Information for operators and users .....	5
3	Structure and functionality .....	6
3.1	General information .....	6
3.2	Structure.....	6
3.2.1	Display (1).....	8
3.2.2	LED strip (3).....	8
3.2.3	Power boards (13).....	8
3.2.4	Connections .....	8
3.3	Identification on the controller .....	9
3.3.1	Wiring of the plug systems.....	9
4	Commissioning.....	10
4.1	Electrical connection .....	10
4.1.1	Mains power supply .....	10
4.1.2	Mains connection.....	10
4.1.3	Connection of the mold .....	10
4.2	Operating and display concept.....	10
4.2.1	Main switch .....	10
4.2.2	Status display .....	11
4.2.3	Operation .....	11
5	Start menu.....	11
5.1	Navigation bar .....	11
5.2	Selection of zones and groups for configuring .....	13
5.3	Navigation menu .....	14
5.3.1	Setup .....	15
5.3.2	Operation .....	25
5.3.3	Settings.....	36
5.4	Index.....	46
5.5	Switch all outputs on and off.....	46
5.6	Standby operation .....	47
5.7	Boost function .....	47
6	Technical data .....	48
7	Dimensions.....	49
7.1	12 zone controller .....	49
7.2	24 zone controller .....	49
7.3	36 zone controller .....	50

7.4	120 zone controller .....	51
8	Appendix .....	52
8.1	Terminal bridges for the star-delta supply .....	52
8.1.1	Terminal bridges in star supply network.....	52
8.1.2	Terminal bridges in delta supply network.....	52
8.2	Pin assignment alarm/ notification socket .....	53
	.....	53
8.3	Pin assignment digital inputs.....	53
8.4	Pin assignment RS485.....	53
9	Index.....	54

Figure 1 - Housing front .....	6
Figure 2 - Housing rear .....	7
Figure 3 – Additional connections with external touch monitor .....	7
Figure 4 - Housing side view .....	7
Figure 5 - Type plate .....	9
Figure 6 - Wiring of plug systems .....	9
Figure 7 - Start screen .....	11
Figure 8 - Navigation bar .....	12
Figure 9 - Sample page for assigning groups .....	13
Figure 10 - Example of the scrollbar with mini view .....	14
Figure 11 - Navigation menu .....	15
Figure 12 - Setup .....	15
Figure 13 - Operation .....	25
Figure 14 - Example of a zone display .....	26
Figure 15 - Settings .....	36
Figure 16 - Star supply .....	52
Figure 17 – Delta supply .....	52

## 1 Introduction

### 1.1 Symbols used

	Caution/Warning	Information on possible damage to property or personal injury
	Information	Important information

### 1.2 Notations

**Menu structures** between words are indicated by the > symbol and depicted in the same way on the device.

**Interaction with the operator** is denoted by the finger symbol  .

## 2 Safety instructions

	Please read this document completely and carefully before commissioning or operating the device.
---	--

### 2.1 Intended use

The hot runner controller is used to control the temperature of heating circuits and is designed for use under precisely defined conditions, such as supply voltage and temperature. The operator must therefore ensure that the controller is only used under operating conditions that comply with the technical data. The manufacturer is not liable for damage resulting from non-compliance with the intended use.

The hot runner controller is not suitable for use beyond the limits defined in the technical data and during its design. In addition, the use of spare parts from third parties and the implementation of non-described maintenance activities constitute failure to comply with the intended use.

Alterations, conversions and other modifications are made exclusively at the operator's own risk and could pose safety hazards. The manufacturer and distributor of this device cannot be held liable for direct and indirect damage resulting from improper handling or treatment.

### 2.2 Information for operators and users

The controllers are operated on the low-voltage network. The relevant safety regulations must be observed when connecting up the controller and performing maintenance on it. In addition, the local and general safety regulations must be observed for its installation and operation. The operator is responsible for compliance with these regulations. The operator must additionally make this documentation available to the user and provide instruction in the correct operation of the device. The user must be familiar with this documentation. In order to ensure reliable and safe operation, the individual user is required to observe the information and warnings. The controllers may only be brought into operation by authorized specialist personnel. Under the terms of these operating instructions, specialist personnel are persons who can recognise and assess the dangers associated with the work entrusted to them on the basis of their specialist training, their experience and their knowledge of standards.

The device is checked carefully prior to delivery and has passed the tests specified in the test plan for its production, in conformity with the manufacturer's valid quality guidelines. To prevent any damage to the controller, it must be transported and stored in the correct manner. Further safety-related notices are marked in the individual sections of this documentation.

### 3 Structure and functionality

#### 3.1 General information

The MCS hot runner controllers are especially suited to the temperature control of hot runner molds on injection molding machines. In use, the controllers are connected directly to the mold via cables.

During operation, the hot runner controllers deliver electric current to the heating units for an injection mold. The so-called heating current leads to an adjustable temperature increase in the heating units and hence in the mold. Continuous temperature monitoring takes place in parallel via connected thermocouples. In the event of deviations between the actual temperature recorded and the temperature set on the hot runner controller, the heating current is automatically adjusted until the two temperatures are identical.

The controllers are available in different variants. These differ solely in terms of the number of control circuits that are possible – which are also referred to as heating zones. Depending on the variant, hot runner controllers are available with either 6, 12, 18, 24, 30 or 36 heating zones.

#### 3.2 Structure

A 12-zone controller is shown by way of example in the figures that follow. All the designated components are identical on controllers with more than 12 heating zones.

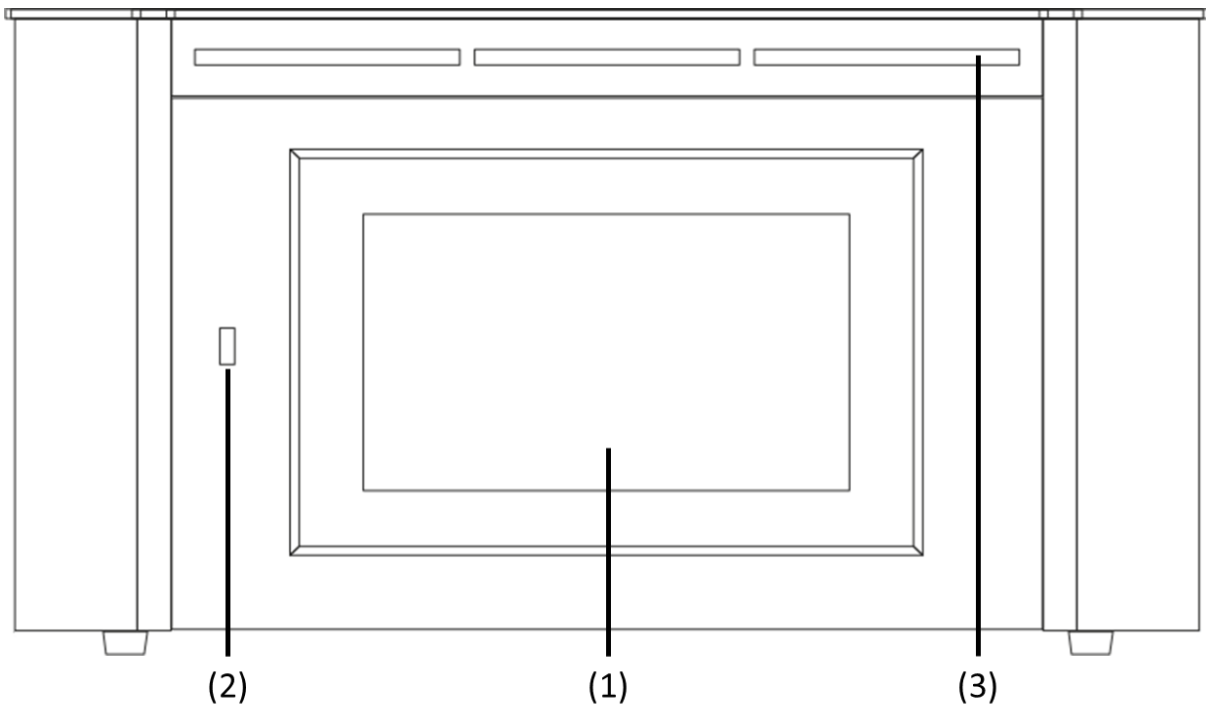

Figure 1 - Housing front

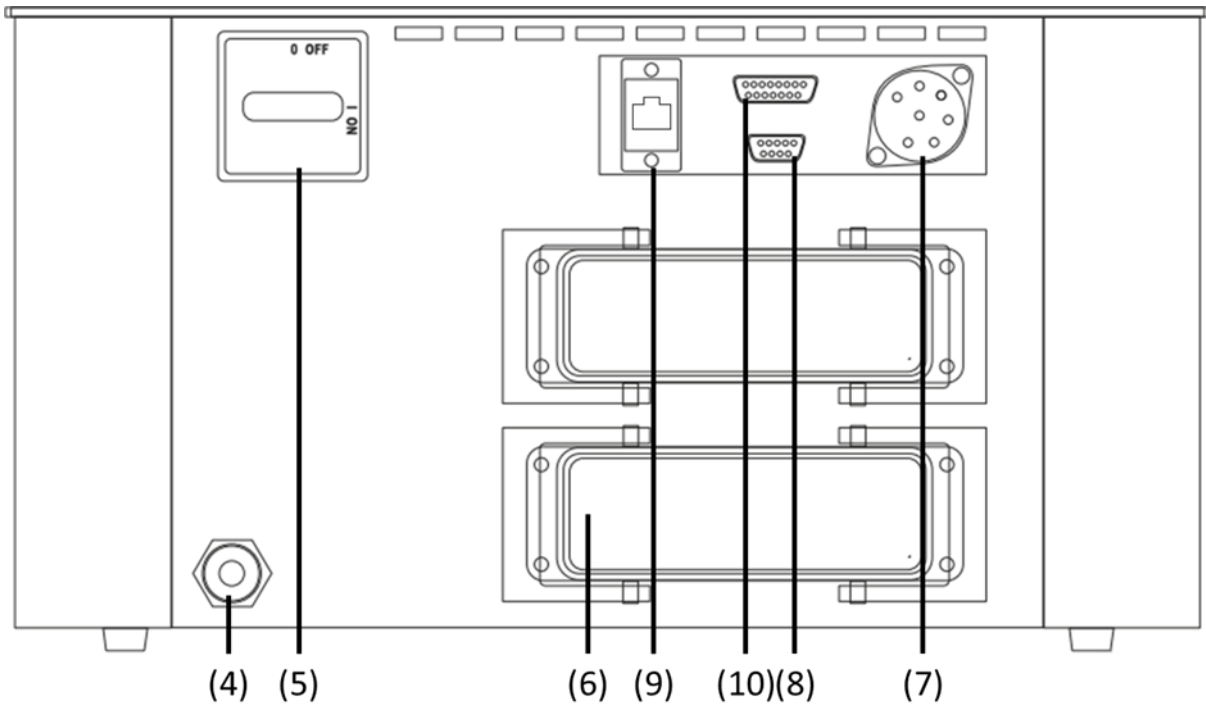

Figure 2 - Housing rear

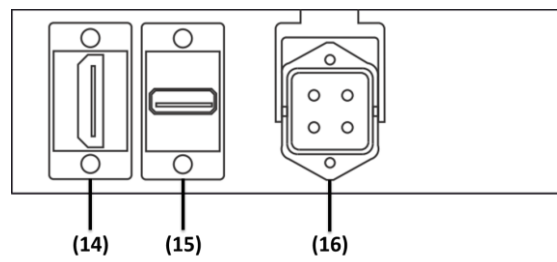

Figure 3 - Additional connections with external touch monitor

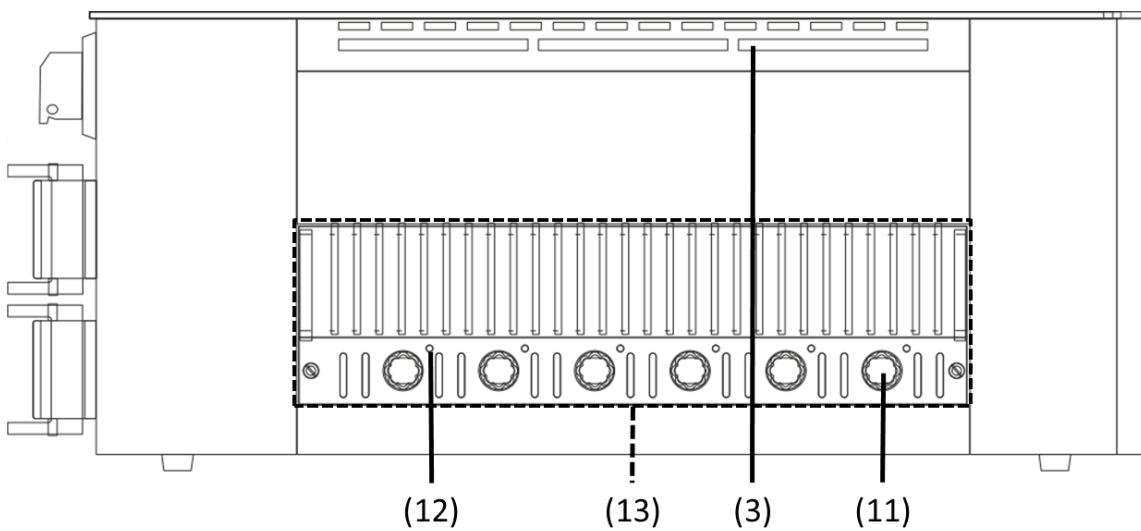

Figure 4 - Housing side view

The following overview describes the main components of the hot runner controller.

- |  |                       |                           |
|--|-----------------------|---------------------------|
| (1) Touch Display                      | (2) USB connection    | (3) LED strip             |
| (4) Connection line                    | (5) Main switch       | (6) Plug system (example) |
| (7) Alarm socket                       | (8) RS485 connection  | (9) Ethernet connection   |
| (10) Digital input                     | (11) Fuse             | (12) Status LED           |
| (13) Power unit                        | (14) *HDMI Connection | (15) *USB Connection      |
| (16) *Power Connection 230VAC, 2,5A mt |                       |                           |

\*only with optional external touch monitor

### 3.2.1 Display (1)

The touch display reacts to finger pressure or can be operated with standard commercial pens that have a rounded plastic tip. For optimum operation, the display can be adjusted to four different positions. This allows an ideal reading and operating angle to be obtained.

	<p>Please note: sharp, pointed objects can damage the display.</p>
--	--

### 3.2.2 LED strip (3)

The controller status is depicted in colour in an LED strip that is visible from a long way off. This permits a rapid assessment of the current controller and mold status.

### 3.2.3 Power boards (13)

The connected heating units are controlled via compact power boards, as is the temperature measurement of the thermocouples. Each power board contains the electronics for heating and measuring six heating zones. The individual boards are mounted at the side of the housing. The heatsink visible from the outside is used for optimum heat elimination and thus increases the service life of the installed electronics. The fuses for the load outputs (11) are located beneath the heatsink.

Each zone is switched off separately via relays on the power board so that individual zones can be switched off individually, and seamless production is always guaranteed.

In addition to the fuse for the load outputs, each power board (13) contains an internal second fuse that is necessary for operation in triangular supply networks. There is also a control fuse on the internal wiring terminals.

### 3.2.4 Connections

In addition to the tiltable display, the front of the housing also has a USB connection. All the other connections are on the rear of the housing. Apart from the thermal and load connections, each controller has alarm contacts, digital inputs and an Ethernet connection.

#### 3.2.4.1 USB connection (2)

The USB connection makes it possible to save and load controller settings, export service files and also update the controller firmware via a flash drive.

#### 3.2.4.2 Ethernet connection (9)

The Ethernet connection is used for communication with additional controllers or an injection molding machine and is located on the rear of the housing.



### 3.2.4.3 RS485 connection (8)

The RS485 interface is used for communication with injection molding machines and is located on the rear side of the housing on a 9-pin D-SUB socket. Further information regarding this interface can be found in chapter 8.4.

### 3.2.4.4 Notification contacts (7)

Each controller has three potential-free alarm contacts that are fed out via a socket on the rear of the housing. By default the alarm contacts open as soon as the controller issues a warning or an alarm. A list of the possible messages is given in Chapter 5.3.2.2.4. A wiring diagram of the alarm contact socket is shown in Chapter 8.2.

### 3.2.4.5 Digital inputs (10)

The controller evaluates 24V DC signals via a 15-pole D-SUB input. The digital inputs are used for the external activation of functions such as standby or locking the outputs. Chapter 8.3 shows the assignment plan for the digital inputs with the corresponding functions. The digital inputs are PLC compatible, i.e. they operate over a voltage range of 13...30 VDC with a typical current consumption of approx. 8.5 mA.

### 3.2.4.6 External touch monitor connection (14), (15) and (16)

Optionally, an external touch monitor can be connected via the connection sockets on the back of the housing. Besides the additional monitor, the connection cable AU-00350 (alternatively AU-00351 or AU-00352) is required.

## 3.3 Identification on the controller

The type plate is mounted on the side of the controller housing. It contains the type designation with the number of zones, the electrical connection data and the manufacturer's data.

<b>Typ / Type</b>		<b>MCS024</b>		
<b>S/N</b>	<b>20091</b>	<b>Prod. KW / CW</b>	<b>30 / 2023</b>	
<b>Code</b>	<b>E7H1-AKB4-C1Z6-87A</b>			
<b>Versorgung / Supply</b>	<ul style="list-style-type: none"> <li>● Y 230/400 VAC 50/60 Hz</li> <li>○ Δ 115/230 VAC 50/60 Hz</li> </ul>			
<b>Belastung / Load</b>	3x 16 A			
<b>Schutzart / IP Class</b>	IP20			
<b>Temp. Fühler / Sensor</b>	Fe-CuNi Type J			
		Made in Germany		
<b>Alarmbuchse / Alarm Socket</b>				
Pin 1+3	Relay 1	Sammelwarnung / collective warning		
Pin 4+5	Relay 2	Sammelalarm / collective alarm		
Pin 2+6	Relay 3			

Figure 5 - Type plate

### 3.3.1 Wiring of the plug systems

The plugs for connecting the temperature sensors and heating elements to a hot runner are available on the rear of the controller. The customer-specific wiring plan for the plug systems is located on the side of the controller housing (see Figure 6 for an example).

Zone	Sensor X1		Load X1	
	+	-	N	230V
1	13	14	2	1
2	15	16	4	3
3	17	18	6	5
4	19	20	8	7
5	21	22	10	9
6	23	24	12	11

Zone	Sensor X2		Load X2	
	+	-	N	230V
7	13	14	2	1
8	15	16	4	3
9	17	18	6	5
10	19	20	8	7
11	21	22	10	9
12	23	24	12	11

Figure 6 - Wiring of plug systems

## 4 Commissioning

### 4.1 Electrical connection

	<p>Important! Before the device is connected to the supply voltage, a check must first be performed to ensure that the mains electricity conditions comply with the specifications on the type plate.</p>
	<p>The electrical connections must be performed by a qualified electrician. Commissioning and operation while the controller is running are only to be carried out by authorised qualified personnel!</p>
	<p>Switching off all the outputs or individual zones will not protect any of the outputs against hazardous voltages. Before working on the connected heating elements, the associated connections must be unplugged, or the entire device disconnected from the mains power.</p>
	<p>Before the device is opened, it must be disconnected from the mains power!</p>

#### 4.1.1 Mains power supply

Before connecting the device to the supply voltage, a check must be conducted to ensure that the mains electricity system is correct. The hot runner controllers are prepared by default for operation in a star network (3x400VAC + N + PE) but can also be operated in a triangular network (3x230VAC + PE). For operation in a triangular network without a neutral conductor, it is essential to follow the local regulations for the installation of electrical systems. The terminals in the controller must be bridged accordingly for use in a star or triangular network. Annex 8.1 contains a clear terminal connection diagram.

#### 4.1.2 Mains connection

To ensure correct operation, the hot-runner controller is connected to the low-voltage mains by using the connecting cable connected to the unit.

#### 4.1.3 Connection of the mold

To connect the individual control zones to the corresponding injection mold, use must be made of appropriate leads for the sensor and heating unit connection.

	<p>Please note: it must always be ensured that the internal wiring, the wiring of the cable set and the wiring in the mold are suitably coordinated with each other.</p>
	<p>Important! To exclude any effects of potential shifts, the injection molds that are connected up must be properly earthed in all cases.</p>

## 4.2 Operating and display concept

### 4.2.1 Main switch



The main switch is located on the rear of the housing. The switch must be activated to switch the controller on and off.

### 4.2.2 Status display

The controller status is indicated on a circulating LED strip. In normal operating mode, this display will be green. In the event of a warning or an alarm, the display will change to yellow or red (traffic light system).

### 4.2.3 Operation

The hot runner controllers are operated exclusively via the integrated touch display on the front of the housing or optionally via an external touch monitor.

	<p>Please note: The heatsinks can become hot during heating. Avoid touching the heating unit!</p>
--	---

## 5 Start menu

A few seconds after the controller has been switched on, the start menu of the user interface appears. In addition to selecting the user language, the most important areas of the controller can be accessed from here.

#### Quick start

The main settings for bringing a new mold into operation.

#### Start with saved settings

Start the heating process with the saved settings.

#### Start with a recipe

Load controller settings that have previously been saved as a recipe.

If the user does not choose anything at this point, the controller will automatically start with saved settings after 30 seconds.

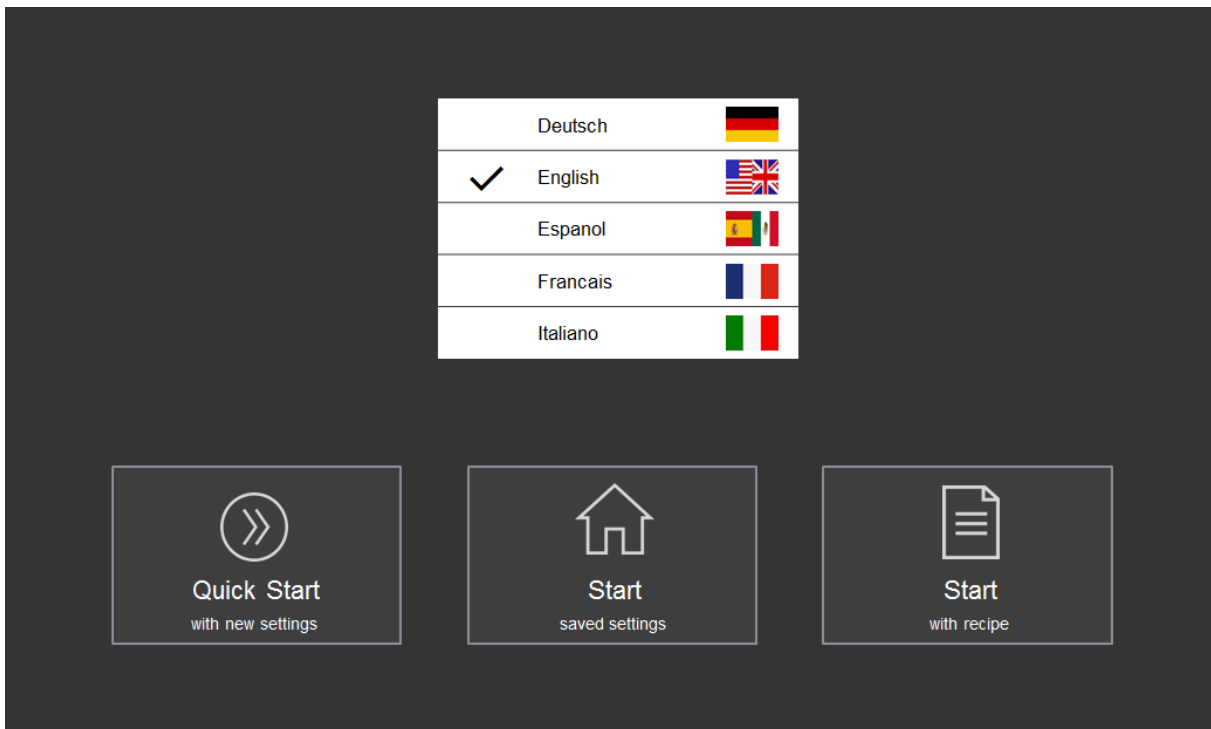

Figure 7 - Start screen

### 5.1 Navigation bar

The navigation bar is always visible at the top of the screen and contains the most important control elements for the controller.

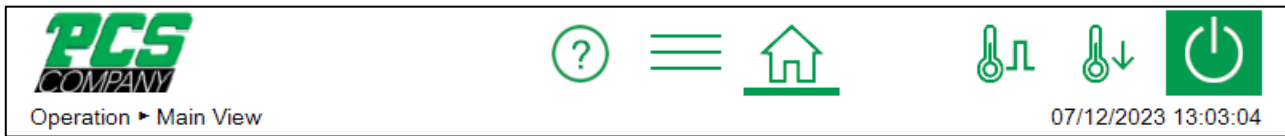

Figure 8 - Navigation bar

Description of the control elements in the navigation bar

Symbol	Brief description	Explanation
	Show and hide the navigation menu	The navigation menu groups all the settings and display options for the controller in its three main areas: setup, operation and settings.
	Show and hide the index of keywords	The keyword index is an alphabetically arranged list of all the functions including the possibility to directly navigate to the respective settings screens.
	Display of the main view	The main view during normal operation provides a zone overview with the most important information at a glance.
	Switch all outputs on and off	Once all the zone settings have been made, this button releases all the control outputs. The button must be pressed at length so as to avoid unintentional operating errors. When the outputs are switched on, the symbol changes to:
	Switch all outputs on and off	Pressing this button switches off all the control outputs. The button must be pressed at length in order to avoid unintentional operating errors. After switching off the outputs, the symbol changes to:
	Switch Standby on	To reduce the setpoint temperatures during production breaks. This button must be pressed at length in order to avoid unintentional operating errors. The symbol changes in lowering mode to:
	Switch Standby off	Press this button to switch off standby mode.
	Activate Boost	Boost can be activated to temporarily increase the temperature setpoint of selected zones (can only be activated if boost has been set and outputs have been switched on).  The symbol changes to when boosting is active:
	Deactivate Boost	Deactivate temperature increase by boosting.
	Diagnosis	This symbol is only visible if faults have occurred. When pressed, it opens the fault overview with the fault handling.
	Timer	This symbol is only visible if the heating timer is activated and the device is switched on or off at the programmed time.
xxxx.rzp	Recipe file	Name of the last recipe loaded. If values have been changed after activation of the recipe, an * is added to the name.
*xxxx.rzp	Changed recipe file	If values were changed after the recipe was activated, the name is highlighted in yellow and also preceded by a *.
	Screenshot	By double-clicking on the company logo, a screenshot button is displayed. When pressed, a screenshot is saved locally. This is available for further processing under "Settings > Device > File management". The button is automatically hidden again after 30 seconds.

## 5.2 Selection of zones and groups for configuring

The page for configuring zone is divided in two parts. The left side of the screen always shows the zone or zone groups that are to be selected. The actual input is then made on the right side.

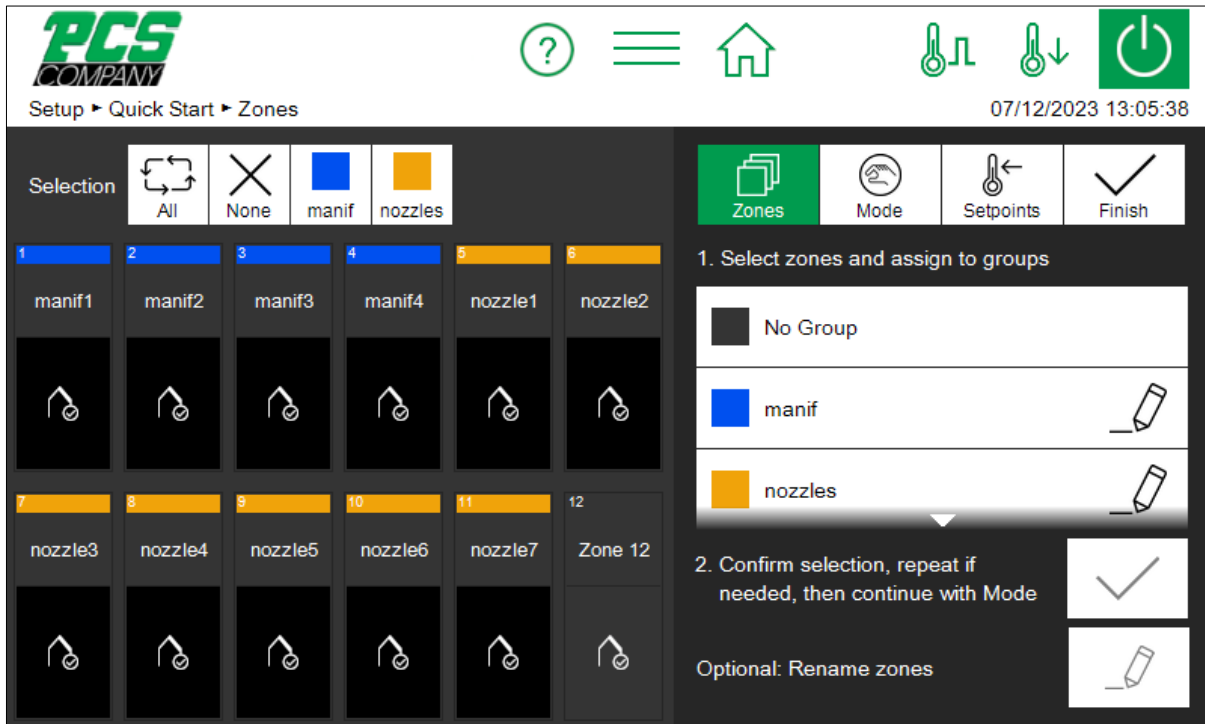

Figure 9 - Sample page for assigning groups

Before zones are operated, they must first be selected. This is done by clicking on the desired zone. A selected zone is highlighted in white. A selected zone can be deselected by clicking on it again (toggle function). The fast selection of several zones is possible by wiping them with the finger without removing. Note that this view displays up to 24 zones at once. Controller with more zones allow scrolling by swiping the zone display up or down.

Zones can be allocated to a freely named group. Zones that belong to a group display their group color under the zone name. To select an entire group of zones, click on the respective group button (above the zone display). To select/ deselect all the zones, click on the "All" button. Operation of the zones is performed on the right side.

If the number of zones is greater than the maximum number that can be displayed on one page, scrolling is required. For an easy overview the scroll bar has a mini display that shows marked zones and messages. As shown in Figure 9, each zone row has 2 rectangular check boxes. If zones in a row have been selected (marked), the left checkbox is displayed in white. The right checkbox indicates the messages of the zone row. As shown in the example, an alarm message is pending for one zone. Even if the corresponding zone is currently not part of the display, the mini display always keeps all zones in view.

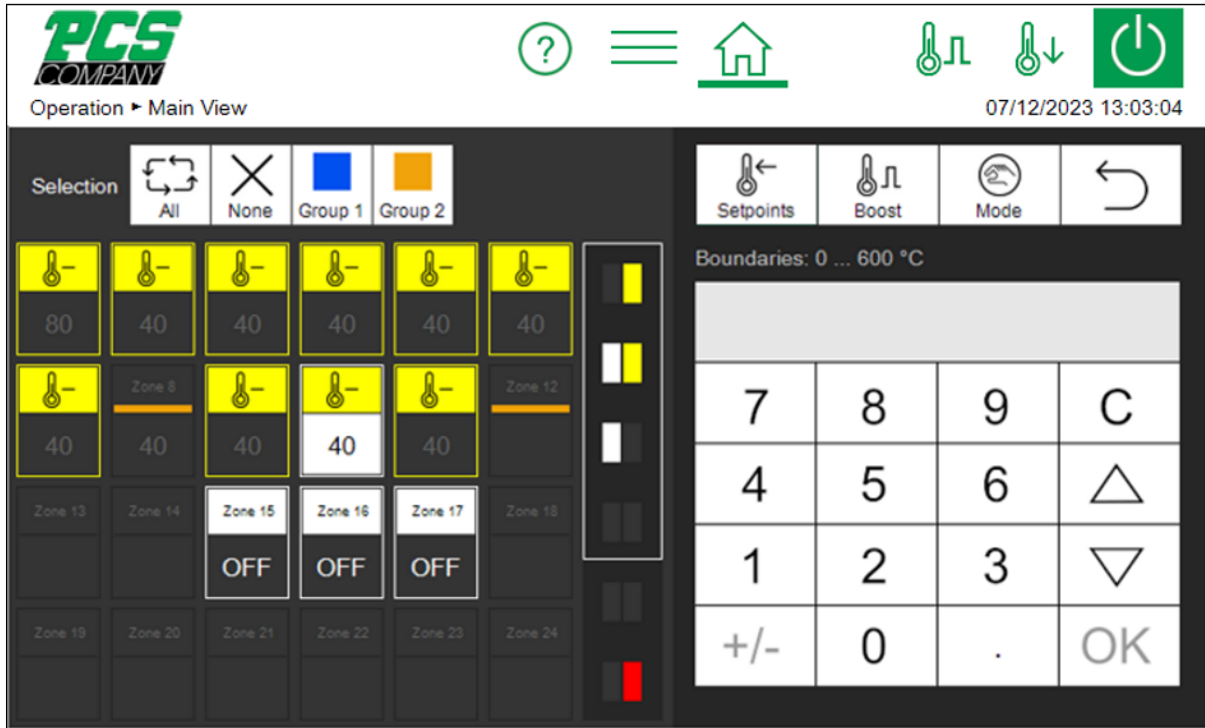

Figure 10 - Example of the scrollbar with mini view

### 5.3 Navigation menu

For a better overview, the navigation menu has been divided into three levels.

- Setup** For setting and configuring the mold-specific settings for all the control zones.
- Operation** For displaying process values and faults during operation and configuring control-related settings
- Settings** For the general configuration and display of information about the controller.

Each of these three main areas is, in turn, divided into subareas that are explained in more detail below.

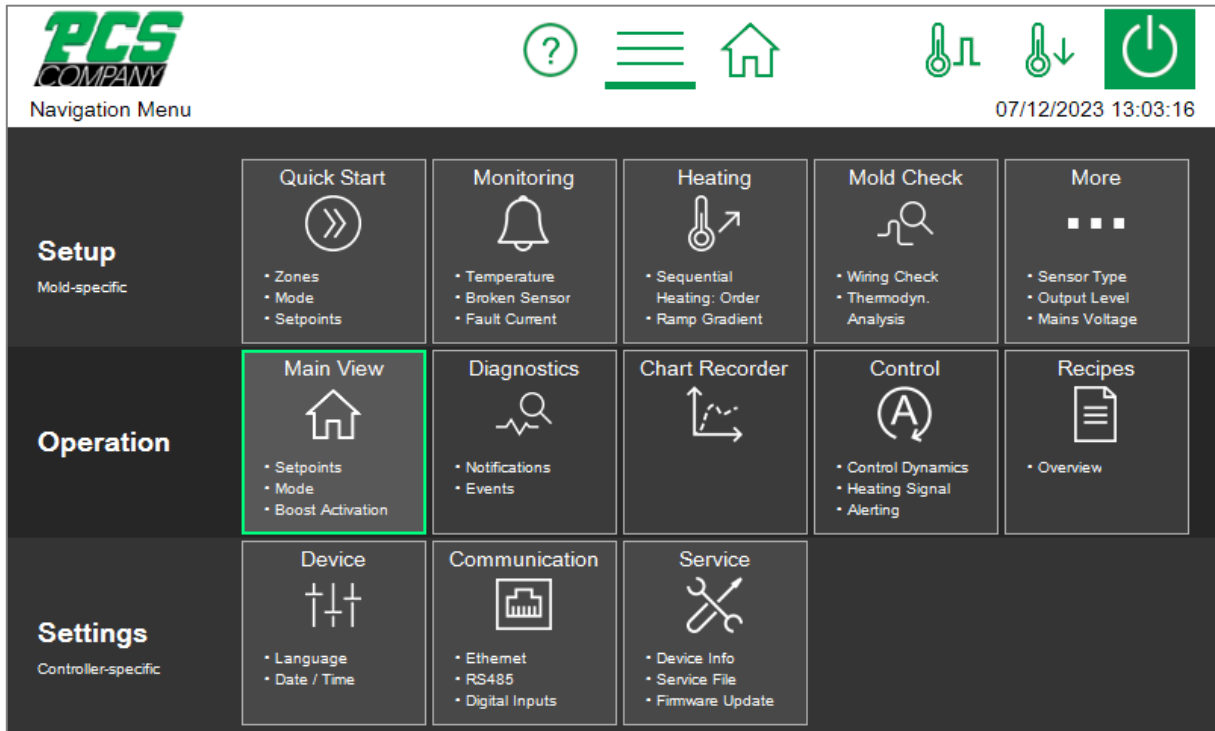

Figure 11 - Navigation menu

### 5.3.1 Setup

All the mold-specific settings should be made before operation. The quick start guides users through the key settings for bringing the controller into operation as quickly as possible. The "Monitoring" menu item is used for monitoring process values and setting the corresponding limits. "Heating" contains functions that can influence the heating process. "Mold Check" is used to test the correct wiring of sensors and heating units. This function is particularly useful after initial installation or after mounting operations but can also be useful for analyzing faults.

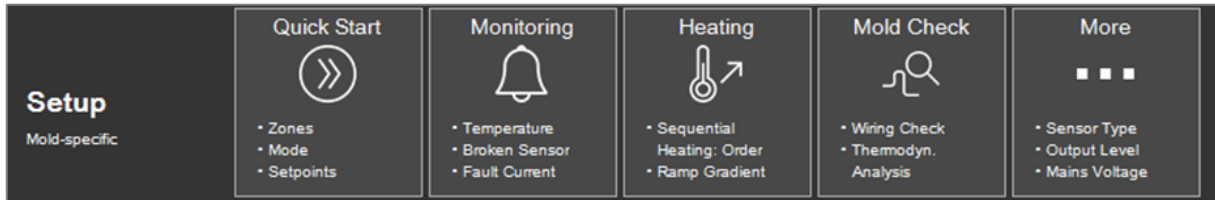

Figure 12 - Setup

The individual functions are explained in more detail below.

#### 5.3.1.1 Quick start



The basic zone settings can be entered in quick start. Zones can be grouped here and setpoint temperatures and operating modes entered for the zones.

### 5.3.1.1.1 Groups and Zone designation



Setup > Quick Start > Groups

Zones can be combined into groups, considerably facilitating operation. It makes sense, for example, to allocate the zones for nozzles and manifolds to different groups. In this way, the grouped zones can be easily selected for simultaneous operation later on. If no groups are to be defined, this section can be skipped.

Procedure: First select the zones on the left that are to be made into a group. Then, on the right side, click on one of the predefined groups and confirm the selection with ✓. The names of the groups are defaulted to Group 1... Group 8 and can be adapted with the symbol where required. In addition, each group is represented by a color. Zones that are assigned to a group indicate this by the corresponding group color above the zone name.

The names of the zones can also be changed. If a group name is changed as described above and zones have already been assigned to this group before, a query will appear to automatically change the zone name according to the group name. Alternatively, the names of single selected Zones can be changed individually using the icon .

If several zones are selected, the last digit in the name of the zones is automatically incremented. However, the actual zone numbering is always retained and prefixed to the new name.

Empty zone or group names reset the name back to the original name.

Factory setting:



All zones without a group

### 5.3.1.1.2 Operating mode



Setup > Quick Start > Mode

In the "Mode" menu item, a specific operating mode can be entered for each zone.

Procedure:

- First select the zones on the left whose operating mode is to be changed .
- Then, on the right side, select one of the operating modes.
- Accept the selection with ✓ .



The following operating modes are defined:

Operating mode	Description
Control Mode 	In normal operating mode, the hot runner controller will control the output in such a way that the measured temperature attains a specified setpoint value. The output level (0...100%) at the output is calculated automatically. In steady state operation, the actual value and setpoint value will be identical.
Manual Mode 	During manual operation, a constant output level will be maintained at the heating output. 0% means that the heating output is permanently off, 100% means that the heating output is permanently on. Manual operation can be used, for example, to manually maintain operation of the control zone until a defective sensor is replaced.
Zone inactive <b>OFF</b>	Zone inactive = Zone is switched off. If the sensor is connected, the temperature monitoring of the cut-off temperature remains active.
Monitoring Mode 	With this setting, a zone can only be used for display and temperature monitoring. No output power is emitted.
Reference Mode <b>Z#</b>	In reference mode the power output (output level) of the reference zone is adopted. This allows to control multiple heaters with a single sensor,

Factory setting:

	All zones will be switched off (OFF).
--	---------------------------------------

### 5.3.1.1.3 Setpoint value

1.

2.

3.

Setup > Quick Start > Setpoints

It is possible to enter setpoint values as the specified temperatures for different situations: for normal operating mode, the standby value and the specified value for boosting.

Procedure:

- First select the zones on the left whose setpoint value is to be displayed or changed.
- On the right side, select one of the setpoint values described below
- Open the box for entering the setpoint value with
- Enter the desired value in the input box

Value	Description	Settings	
Setpoint	Specified temperature for a zone in normal operating mode.	Min:	0 °C
		Max:	600 °C
		Standard:	0 °C
Output Level	The output level can be set manually. However, this value will only be applied to zones in manual mode or with a broken sensor and corresponding broken sensor behaviour set to a specific output level.	Min:	0%
		Max:	100%
		Standard:	0%
Standby temperature	It is recommended that use be made of the standby function to protect the plastic melt and reduce energy costs. The standby temperature can be specified here as a function of the materials used. This determines the value to which the zones should cool down. The standby function is activated in the menu bar with the “Pause” button  or, alternatively, via a control input.	Min:	0 °C
		Max:	300 °C
		Standard:	150 °C
Boost Offset	By implementing the boost function, the setpoint temperature for individual zones or groups is raised by an adjustable value for a specified period of time. This function can be used to heat up nozzle tips in order to clear them prior to start-up. The boost function is activated from the home view. The editor with the boost button can be opened by clicking on a zone.	Min:	0 K
		Max:	50 K
		Standard:	0 K
Boost Duration	For setting the time mentioned above for which a zone is to be boosted	Min:	0 sec
		Max:	900 sec
		Standard:	60 sec

### 5.3.1.2 Monitoring

#### 5.3.1.2.1 Temperature monitoring

---



1. 

2. 

3. 

---

Setpoint > Monitoring > Temperature

---

Different temperature limits can be set on the temperature monitoring page.

Procedure:

- First select the zones on the left whose temperature limit is to be changed (see chapter Selection of zones and groups for )
- On the right side, select one of the values described below
- Open the box for entering the setpoint value with 
- Enter the desired value in the input box
- Confirm with OK.

Value	Description	Settings
High Temperature Limit	If the actual value exceeds the limit value set here, the corresponding zone will depict a corresponding symbol:  The LED strip will light up red and the zone will temporarily turn off its output. A potential-free contact can signal this alarm to the outside. If the actual value falls below this limit value, this alarm will automatically deactivate.	Min: 0 °C Max: 600 °C Sensor type L 800 °C Sensor type K Standard: 400 °C
Upper Tolerance Range	For temperature monitoring, a tolerance range can be specified above the set-point. If the actual value is over the upper tolerance range, this will be signaled as a warning. This is depicted on the relevant zone with a warning symbol() The LED strip will light up yellow. A potential-free contact can signal this alarm to the outside. The outputs will not be switched off.	Min: 1 K Max: 600 K Standard: 15 K
Lower Tolerance Range	For temperature monitoring, a tolerance range can be specified below the set-point. If the actual value is under the lower tolerance range, this will be signaled as a warning. This is depicted on the relevant zone with a warning symbol() The LED strip will light up yellow. A potential-free contact can signal this alarm to the outside. The outputs will not be switched off.	Min: 1 K Max: 600 K Standard: 15 K
Low Temperature Limit	If the actual temperature falls below the limit value set here, the relevant zone will be marked with a corresponding alarm:  The LED strip will light up red. A potential-free contact can signal this alarm to the outside. If the actual value exceeds this limit value, the alarm will be automatically deactivated.	Min: 0 °C Max: 600 °C Standard: 0 °C
Shut-off Temperature	If the actual value of <u>one</u> zone exceeds the shut-off temperature set here, <u>all</u> the zones will be switched off. All zones will be marked with a corresponding alarm:  For the relevant zones the corresponding alarm flashes. The LED strip will light up red. A potential-free contact can signal this alarm to the outside. The controller can only be operated again with an error confirmation or a restart.	Min: 0 °C Max: 600 °C Standard: 500 °C
Temperature Offset	The temperature offset is added to the actual value and affects its display and temperature monitoring.	Min: -50 °C Max: 50 °C Standard: 0 °C

### 5.3.1.2.2 Broken sensor monitoring



- 1.
- 2.
- 3.

Setup > Monitoring > Broken Sensor

The controller behaviour in the event of a broken sensor during normal operation is set out here.

Behaviour	Description
Output Level 0%	The zone reports an alarm and adjusts the output level to 0%.
Average Output Level YM	The zone reports sensor break as an alarm and then switches to the previously averaged output level.
Defined Output Level	The zone reports sensor break as an alarm and then switches permanently to the output level that can be adjusted here. The output level can be specified after pressing the  button and is displayed at the zones.
Output level of Reference zone	The zone reports sensor break as an alarm and then switches to the output level of a reference zone that can be defined here. The reference zone can be specified after pressing the  button and is displayed at the zones with Zxxx (xxx = number of the reference zone).

In the "Setup > More > Sensor type" menu, the monitoring can also be completely deactivated by selecting "No sensor".

### 5.3.1.2.3 Fault Current Monitoring



- 1.
- 2.
- 3.

Setup > Monitoring > Fault Current

Behavior	Description
No Signal	Fault current monitoring is switched off
Only Signal	Fault current monitoring detects fault currents that flow on account of moisture in the mold or insulation damage. If "Only Signal" is selected, fault current monitoring is activated and an alarm is generated if the limit value is exceeded.
Signal and dry out	If "Signal and dry out" is selected, fault current monitoring is activated. If the limit value is exceeded, an alarm will be generated and, in order to dry out the mold, all the zones will be heated up to 100°C until the fault current falls below the limit value. If the alarm doesn't disappear after drying out an insulation damage. Note that the alarm could also

The factory setting is: Signal and dry out

### 5.3.1.2.4 Leakage monitoring



- 1.
- 2.
- 3.

Setup > Monitoring > Leakage

Leakage monitoring is used to detect irregularities in the heating behavior. These can occur, for example, in the case of a leaking nozzle where liquid plastic can escape (plug formation). Monitoring is based on the average output level, which is automatically calculated and continuously updated in the stable process.

Value	Description	Settings
Output: Reference Value	The average output level calculated during normal operating mode can be monitored. If the calculated value deviates from this reference value, it could be a sign of an irregularity in the controlled system. There could perhaps be leakage in the nozzle. Setting this to "0" switches off the monitoring. With  , the currently calculated average output level is accepted and set as the new reference value for monitoring. Alternatively, an expected average output level can be specified via	Min: 0 % Max: 100 % Standard: 0% (off)
Output: Tolerance	If the current output level exceeds or falls below the reference value by the set tolerance, a warning is generated. The LED band lights up yellow (depending on the "Alarm leakage" parameter) and the relevant zone is marked with a symbol on the touch display. A potential-free contact can signal this alarm to the outside. The outputs will not be switched off.	Min: 0% Max: 100 % Standard: 20 %
Alarm leakage	This parameter determines whether an alarm or a warning is generated when a deviation is detected. The respective message contact is also switched accordingly.	Standard: Warning



### 5.3.1.2.5 Heating current monitoring







- 1.
- 2.
- 3.

Setup > Monitoring > Heating current

Heating current monitoring is used to detect defective heating units or supply lines. A message is generated if the measured current deviates from the specified reference value.

Value	Description	Settings
Current: Reference Value	The heating current to be monitored can be specified here. Any deviation is calculated on the basis of this reference value. With  , the current heating current is accepted as a reference value and set for monitoring. Alternatively, an expected heating current can be specified via  . Entering a setting of 0.0 A will switch off the monitoring. The current will, however, continue to be displayed.	Min: 0,0 A Max: 40,0 A Standard: 0,0 A
Current: Tolerance	The tolerance set here is the maximum permitted deviation of the present heating current measured from the reference value. If the heating current exceeds or falls below the tolerance, a warning will be generated. The LED strip will light up yellow and, on the touch display, the relevant zone will be marked with a warning symbol  .	Min: 0,0 A Max: 16,0 A Standard: 0,5 A

### 5.3.1.2.6 Production cycle monitoring

 1. 
 2. 
 3. 
  
 Setup > Monitoring > Production Cycle



For production cycle monitoring, there must be a connection between the injection molding machine and the controller. The signal must be connected to pin 10 of the controller's control inputs.

Value	Description	Settings
Auto-Standby Timeout	The AUTO STANDBY function monitors the production cycle and automatically switches to standby after a configurable timeout if the machine comes to a standstill.	Min: 0 s Max: 999 s Standard: 0 s (inactiv)

### 5.3.1.3 Heating

 1. 
 2. 
  
 Setup > Heating

The heating behaviour of each individual zone can be selected here.

Function	Description	Settings
Max. Temperature Difference	The maximum temperature difference defines by how much the zones within the same priority group are allowed to deviate. This value is called the maximum temperature deviation.	Min: 1° Max: 100° Standard: 25°C
Sequential Heating: Order	Heating of zones in a defined order heating avoids thermal disbalances in the mold by grouped, smooth heating with respect to the slowest zone. When heating the zones are grouped by their priority and each priority group is heated sequentially starting with 1. The maximum temperature difference is kept for zones in the respective priority group. Factory setting: All zones in Group 1 (all values = 1)	Standard: 1
Cooling Limit	In accordance with the order of sequential heating, sequential cooling in reverse order is also possible by setting a cooling limit value per zone. When the controller is switched off, the zones that last heated up cool down first. When all these zones have reached their cooling limit value, the next zones start cooling. As soon as no more zones heat up, the controller switches off automatically.  Cooling is indicated by alternating flashing of  and  . To cancel sequential cooling, press  . In the window that appears, you can choose between switching off all heating zones immediately and heating up again.	Min: 0° Max: 500° Standard: 0 (0= no sequential cooling)

Softstart	The softstart enables gentle heating of the mold. All the zones are heated separately and gently to a maximum of 100°C, independently of a higher setpoint temperature. Up to a temperature of 50°C, each zone is heated with a maximum output level of 50%. The output level is then slowly increased to 100% as a function of the actual value. Once 100°C has been reached, the soft start has been completed and the zone can heat up at full power.	Standard:	Soft start is activated for all zones
Ramp Gradient	The ramp function is executed when a setpoint value is changed. It ensures that the new setpoint is approached at an adjustable, constant rate.	Min:	0,00°C / sec
		Max:	99.99 °C / sec
		Standard:	0°C / sec

### 5.3.1.4 Mold Check

#### 5.3.1.4.1 Wiring Check

1.

Setup > Mold Check > Wiring Check

2.

3.

The wiring check tests the sensors and heating units and is particularly useful after initial installation or assembly work, and also in the event of irregularities during normal operation. The wiring check detects: mixed up sensors, heating units and plugs as well as sensor polarity reversal and short-circuiting. Irrespective of the selection, all zones will be monitored.

First of all, select the zones which should be tested. To start the test, press the start button . The selected zones will now be tested one after the other. The status of the zones during the test will be represented by the following symbols:

Function	Description
0:25	This zone is currently being tested. The duration of the mold check for this zone is shown in minutes: seconds.
	The mold check for this zone has been successfully completed.
	Zone in the queue.

The wiring check can be interrupted at any time with the pause button and cancelled with the stop button . In addition, individual zones can be skipped during the test using the forward button . If an error is detected on a tested zone, the controller immediately alerts and aborts the test.

After each test, the result can be saved via the button . In addition, the protocol of the last executed test is also available for export afterwards via this button.

#### 5.3.1.4.2 Thermodynamic Analysis

1.

Setup > Mold Check > Wiring Check

2.

3.

Thermodynamic analysis (TDA) is intended to compare the thermodynamic condition of a tool with a good condition previously stored as a reference. From the differences found, damage or possible problems of the mold can be deduced, if necessary. The thermodynamic analysis records electrical parameters as well as heating and cooling rates, and average values during control at the operating point.

### Procedure of the thermodynamic analysis

The thermodynamic analysis must be started in the cold state of a mold. The heaters are initially switched off. The setpoint of the zones to be tested must be at least 150 °C. After selecting the zones to be tested, the TDA can be started via the Start button. The analysis is divided into 5 phases, which are described below. During the course of the TDA, the view of the controller can be changed to other pages at any time. The TDA continues to run in the background.

Phase 1: After starting the TDA, the heaters are automatically switched on and all selected zones are classified simultaneously. The respective heating rate (gradient) is determined in the process.

Phase 2: After classification, the zones heat up to the set target value. Set heating behaviors, such as compound heating, are taken into account. The difference to the setpoint is displayed in the zone overview of the thermodynamic analysis.

Phase 3: After the setpoint values have been reached, a soak time, adjustable in minutes, begins. During this time, the setpoint is maintained, no further evaluation takes place. The remaining time is displayed in the TDA overview.

Phase 4: After the warm-up time has elapsed, a measuring period adjustable in minutes starts. During this time, the output required for control is recorded. The remaining time is displayed in the TDA overview.

Phase 5: After the measuring period, the heaters are switched off. The cooling phase begins. All zones cool down by the value set as "cooling difference". The setting of 0° means that the cooling phase is skipped. The current cooling difference is displayed in the TDA overview.

After all phases have been run through, the thermodynamic analysis is finished. The result button shows the set boundary conditions and the determined parameters of the analysis. The result is automatically saved in a file. Different test results can be compared with each other. By default, the deviations of the two tests are displayed as percentages. The Details button displays the test results as numerical values. Deviations of more than 10% are highlighted in yellow. The Protocol button can also be used to generate a formatted protocol that creates a tabular overview for evaluation on a PC.

#### 5.3.1.4.3 Settings

- 1.
- 2.
- 3.

Setup > Mold Check > Settings

With the subitem "Settings" the following functions of the mold test can be adjusted:

Function	Description	Settings
Wiring Check Timeout	The wiring check usually detects a sensible duration based on the responsiveness of the zone. For extreme heating circuits this can be overridden by setting a specific diagnosis time. When exceeding this time, the test will fail with timeout.	Min: 0 s Max: 900 s Standard: AUTO (0 s)
Abort check on error (Wiring Check)	The wiring check is usually aborted if the test fails for a zone or if any of the selected zones reports an alarm. This is supposed to make it easier to find problems in the wiring. The described behavior can be changed by this parameter – for example, to get a complete protocol.	Standard: "Abort check on error active"
Wiring Check Temp. Increase	The temperature increase that should be reached during the wiring check is set here. Only if this temperature increase is reached, a test can be considered as OK.	Min: 0°C Max: 50°C Standard: 5°C
Heat Soak Time (Thermodynamic Analysis)	The heat soak time delays the acquisition of performance data after the heating phase. This allows for a more accurate test result, as a warmed through tool requires less energy to maintain the set point.	Min: 1 minute Max: 300 minutes Standard: 10 minutes
Measurement (Thermodynamic Analysis)	The measuring period determines the time period over which power data is recorded and averaged. After the measuring phase, the outputs are switched off again.	Min: 1 minute Max: 300 minutes Standard: 10 minutes
Cooling Difference (Thermodynamic Analysis)	Following the measurement phase, the zones are individually cooled to the setpoint minus the cooling difference. The cooling gradient is recorded and averaged over this difference. If the cooling difference is 0, the entire cooling phase is skipped.	Min: 0°C Max: 50°C Standard: 5°C

### 5.3.1.5 More

#### 5.3.1.5.1 Sensor Type

---

1.

2.

3.

Setup > More > Sensor Type

---

The sensor type to be used for the temperature measurement can be determined here. The two thermocouple types FeCuNi Type J and NiCrNi Type K are available for selection.

It is also possible to select “No sensor”. In this case, either no sensor is available, or the sensor is not used. The selected zones then have no actual value and all the temperature-related alarms, signals and logs are deactivated.

	<p>Please note:</p> <p>No monitoring is performed for values exceeding or falling below temperature limits, and no sensor breaks are signaled. No entries relating to this are made in the event list.</p>
--	--

#### 5.3.1.5.2 Max. Output Level

---

1.

2.

3.

Setup > More > Output Level

---

The maximum output level serves to limit the output power of the controller outputs. Normally, the output level is within the limits 0% to 100%. The upper limit can be set to a new value by limiting the output level. The output level is then limited to this new value.

In the zone display, the output level will be placed in brackets once the output level limit is attained. In the following example, an output limit of 70% is shown in the zone display.

	Zone 2
Act [°C]	235
Set [°C]	248
Y [%]	(70)

Display of the output level limit:  
Output level Y is currently limited to 70%.

Setting limits: 0 ... 100%  
Factory setting: 100%



### 5.3.1.5.3 Mains Voltage

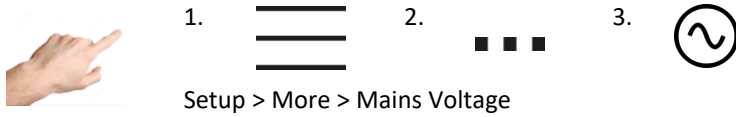

Function	Description	Settings
Mains Voltage	To calculate the consumed power, the voltage of the supply network is entered here.	Min: 100 V Max: 300 V Standard: 230 V

 The specification is only used for the mathematical representation. An incorrect specification will result in an incorrect calculation of the power in the main view.

### 5.3.2 Operation

Under operation, the main functions that are required during the process can be selected. This includes the home view for changing the setpoint values, output levels and operating modes, the diagnosis for fault analysis, the plotter for analyzing zone profiles over time, the control parameters and an overview of all parameters that can be saved as a recipe.

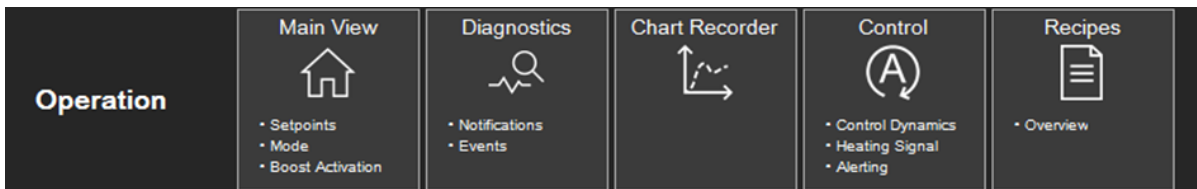
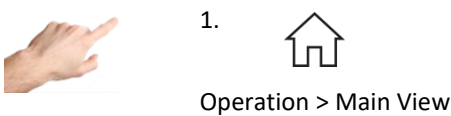

Figure 13 - Operation

These functions are described in greater detail below.

#### 5.3.2.1 Main View



The main view shows all the zones with their process values, faults and information on the operating status.

##### 5.3.2.1.1 General presentation

The view is depicted in the following manner:

Zone status	Presentation
Zone active	Black background
Zone inactive	Grey background. Zone is off.
Manual	Zone in manual operation, process values in blue
Monitor	Zone in monitoring operation, process values in orange
Boost	Zone in boost mode
Standby	Zone in standby mode
BSB	Behaviour in the event of sensor break is depicted in the zone designation box: BSB = Broken Sensor Behavior
Fault icon	The fault icon flashes in the zone designation box. Clicking on the fault icon will call up the diagnosis.
Combined	The zone belongs to a heating group and is uniformly heated together with the other zones in the group.

Combined*	This zone is the most inert zone in the group that is currently being heated.
Empty box	A box for displaying a process value remains empty if the set operating mode is not relevant for this process value. Example: in monitoring mode, no output level is output and hence the process display for the output mode remains empty.
(50%)	The output level display in brackets means that the output level is currently limited. This can be the case during the heating phase with a soft start, for example.
	The actual value display with this symbol means that no valid actual value is being measured. This symbol only occurs in combination with faults such as a sensor fracture or CAN faults.
Optimizing	The controller automatically determines the control parameters.
Check	Zones which are selected for mold check.
Check*	Zone which is currently tested by mold check

**Example:**

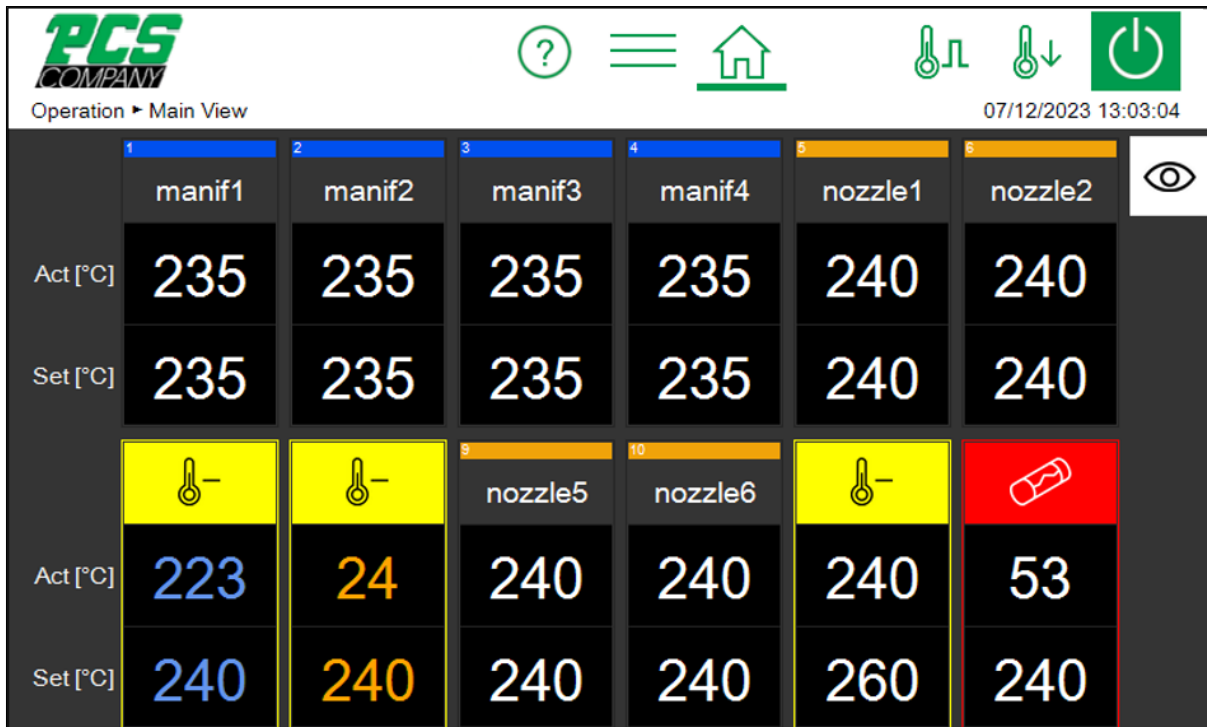

Figure 14 - Example of a zone display

Individual zone display:

The button is on the right side of the screen (until Firmware 2.3, button "Display"). Here, the process values that can be displayed per zone can be selected from a range of process values. The zone display can thus be individually defined with just a few clicks. A click on the process value causes an immediate change in the display. A maximum of eight process values can be displayed per zone. In the further course you will find a list of all process values that can be displayed.

In addition, zones can be filtered in the menu so that they are not displayed in the main view. The filter can be applied to

- Inactive zones
- and
- zones of a certain group.

If zones are hidden in the main view, this is indicated by the filter symbol.

The following process values are available for selection:

Process value	Description
Actual value	The actual temperature measured on the sensor
Setpoint	Specified setpoint temperature
Output Level	Controller output signal
Power	Power output to the heaters (calculated value)
Heating current	Heating current flowing through the heating units
Temperature Deviation	Actual value - Setpoint value
Temperature Deviation, graphical	Graphic presentation of the control deviation by means of a bar. The height of the bar corresponds to the control deviation. If the control deviation exceeds the tolerance range, the bar will turn yellow. If it exceeds the limit for an excessively high temperature, it will turn red. The maximum display range for the control deviation can be specified with the "Tolerance range" parameters. Setup > Monitoring > Temperature
Control Quality	From the control quality displayed, it is possible to see how constantly the zone can maintain the setpoint value. 100% indicates that over a period of at least 10 minutes, temperature deviation from the setpoint is less than 0,1 K in °C and 0,18 K in °F. Each percent less of the maximum value 100% means 0,2 K in °C and 0,36 K in °F more deviation from the setpoint. Zones with process-related, short-term tolerances (friction, injection cycle) have a lower quality.
Mean Output Level	The mean output level is the average output level that has been output over a specified period of time.
Fault Current (Phase)	Currently measured fault current for every phase.
Internal Setpoint	The internal setpoint value is the setpoint value currently employed for control. Depending on the operating conditions and functions, the internal setpoint value may deviate from the actual setpoint value. In standby mode, for example, the controller applies the set standby temperature. In this example, the internal setpoint value would display the standby temperature.
Temperature gradient	Temperature rise during heating.

The following examples illustrate the different presentations:

Presentation	Description						
<table border="1"> <tr> <td></td> <td>Zone 1</td> </tr> <tr> <td>Act [°C]</td> <td>23</td> </tr> <tr> <td>Set [°C]</td> <td>OFF</td> </tr> </table>		Zone 1	Act [°C]	23	Set [°C]	OFF	<p>Zone 3 is inactive, the outputs are deactivated.</p> <p>The display boxes for the process values remain greyed out. The actual value is displayed.</p>
	Zone 1						
Act [°C]	23						
Set [°C]	OFF						
<table border="1"> <tr> <td></td> <td>Zone 1</td> </tr> <tr> <td>Act [°C]</td> <td>235</td> </tr> <tr> <td>Set [°C]</td> <td>238</td> </tr> </table>		Zone 1	Act [°C]	235	Set [°C]	238	Active zone with the actual and setpoint value display
	Zone 1						
Act [°C]	235						
Set [°C]	238						

	Zone 1
Act [°C]	235
Set [°C]	238
Y [%]	15
I [A]	8,5

Active zone with 4 process values:

- actual value
- setpoint value
- output level
- heating current

	Zone 1
Act [°C]	240
Set [°C]	230
$\Delta T$ [°C]	

Active zone with actual and setpoint value and graphic display of the control deviation  $\Delta T$ .

If the bar display for the control deviation is above the zero line, the actual value is too high. In this example, the actual value is 10° above the setpoint value.

The display range of the bar corresponds to the tolerance range value, in this case 20°.

	Zone 1
$\Delta T$ [°C]	

Active zone with graphic display of the control deviation.

If the bar display of the control deviation is below the zero line, the actual value is too low.

	Zone 1 Monitor
Act [°C]	250
Set [°C]	230
$\Delta T$ [°C]	

Zone 1 in monitoring mode with the actual value, setpoint value and the graphic control deviation.

Process values in monitoring mode are shown in orange.

The yellow bar indicates that the actual value is outside the tolerance range.

In the example, the tolerance range is 10° and the control deviation 20°.

	Zone 1 Combined*
ActI [°C]	235
Y [%]	25

Active zone with the actual value and output level display.





Zone 1 is heated up in a group.

“\*” means that this zone is the most inert in the heating group. All the other zones in the heating group show “group” without an “\*”.

	Zone 1 Optimizing
Act [°C]	235
Y [%]	25

After it is switched on, the controller establishes the optimum control parameters (automatic optimization).

As soon as the optimum control parameters have been found, the word “Optimizing” will disappear.

<p>Act [°C]</p> <p>Set [°C]</p>	<p>Zone 1 Manual</p> <p><b>235</b></p> <p><b>238</b></p>	<p>Zone 1 in manual operation</p> <p>Process values in manual operation are shown in blue.</p>
<p>Act [°C]</p> <p>Set [°C]</p>	<p></p> <p><b>200</b></p> <p><b>238</b></p>	<p>Zone with fault indication "Negative temperature deviation".</p> <p>The warning signal with the yellow background flashes.</p> <p>Pressing the warning signal will open diagnostics.</p>
<p>Act [°C]</p> <p>Set [°C]</p> <p>Y [%]</p>	<p>Zone 2</p> <p><b>235</b></p> <p><b>248</b></p> <p><b>(70)</b></p>	<p>Active zone with 3 process values:</p> <p>In this example:</p> <ul style="list-style-type: none"> <li>- actual value</li> <li>- setpoint value</li> <li>- output level: the output level is currently limited to 70%.</li> </ul>
<p>Act [°C]</p> <p>Y [%]</p>	<p>Zone 1 Monitor</p> <p><b>250</b></p>	<p>Zone 1 in monitoring mode with actual value and output level.</p> <p>The output level display remains empty because no output level is output in monitoring mode (outputs are switched off).</p>
<p>Act [°C]</p> <p>Set [°C]</p>	<p>Zone 1 Boost</p> <p><b>235</b></p> <p><b>260</b></p>	<p>Zone 1 is in boost mode.</p> <p>Display in this example:</p> <ul style="list-style-type: none"> <li>- actual value</li> <li>- setpoint value for boost (parameterized setpoint plus boost increase)</li> </ul>
<p>Act [°C]</p> <p>Set [°C]</p>	<p>Zone 1 Standby</p> <p><b>120</b></p> <p><b>120</b></p>	<p>Zone 1 is in standby mode.</p> <p>Display in this example:</p> <ul style="list-style-type: none"> <li>- actual value</li> <li>- setpoint value for standby</li> </ul>
<p>Act [°C]</p> <p>Set [°C]</p>	<p></p> <p></p> <p><b>237</b></p>	<p>Zone with "Sensor failure" fault display.</p> <p>The alarm signal with the red background flashes.</p> <p>Pressing the alarm signal calls up the diagnosis.</p> <p>The triangle with an exclamation mark indicates that no valid actual value is available.</p>
<p>Act [°C]</p> <p>Set [°C]</p>	<p>Zone 1 BSB: 0%</p> <p></p> <p><b>237</b></p>	<p>The behaviour in the event of broken sensor (BSB) is shown in the zone designation box.</p> <p>In the present example, the setting is "BSB=0%", which reduces the output level to 0% in the event of sensor fracture.</p>

### 5.3.2.1.2 Changing the setpoint value and output level

To change the setpoint value and output level in the home view, simply click on a zone.

Editor mode will then open, with selection buttons in the top right half of the screen and a numeric keyboard for entering the values. First of all, the zones that shall be changed are selected. This can be done by clicking on the individual zones or by using the “All” selection button. If groups have also been defined in the quick start, these will similarly appear in the selection. By clicking on a group, the corresponding zones will automatically be selected.

By clicking on a group and then pressing the OK button, it is now possible to change the setpoint value or the output level for the selected zones, depending on which operating mode is active for the selected zones.

### 5.3.2.1.3 Activating the boost function

If the selected zones are to be boosted, the “Boost” selection button should be pressed. A window will then open for activating the boost function. The boost process is started by pressing the boost button. The background of the boost button will change colour to indicate that the boost is in progress. The background of the button acts like a progress bar, just in the other direction. As the duration increases, the coloured background decreases in size until the boost has finished. It is thus possible to see at a glance how long the boost process still has to run.

Example	Description
	Boost function not activated
	Boost function just started.
	The boost function has now run for half of the boost time.
	The boost function now has only 1/4 of the boost time to run.

### 5.3.2.1.4 Changing the operating mode

The procedure for changing the operating mode is precisely the same as that described in Chapter 5.3.1.1.2. Pressing on the “Operating mode” button will call up the window for setting the operating mode. It is now simply a matter of following the guided dialogue:

1. Select the zones for which the operating mode is to be changed and select the operating mode for these.
2. The selection is accepted by pressing the confirmation button.

## 5.3.2.2 Diagnostics



### 5.3.2.2.1 Faults

	1.	2.	3.
Operation > Diagnostics > Faults			





The Faults menu provides a convenient overview and explanations of existing warning and alarm-messages and alarms. For rapid assistance in the event of a fault, it is also possible to navigate to the troubleshooting function. This contains information and explanations on the type of fault and its cause.

Procedure:

- First select a pending warning or alarm on the left side.
- An explanation of the fault will then appear on the right side.
- can be used to navigate in the fault handling function (see Chapter 5.3.2.2.3.)

	Critical faults must be acknowledged with  . Otherwise, it will not be possible to switch on the affected zone again.
---	--

**5.3.2.2.2 Events**

	1. 	2. 	3. 
	Operation > Diagnosis > Events		

The events view contains a list of date and time-dependent controller information. In addition to all the warnings or alarms that occur, user logins and parameter settings are documented. The list is filled and overwritten automatically. The last 1000 entries are always displayed. The event list also is included in the service file (see Chapter 5.3.3.3) and can thus be saved and exported for evaluation.





**5.3.2.2.3 Troubleshooting**

As soon as the controller issues a warning or an alarm about a status change, the malfunction symbol  appears in the status bar. Pending warnings and alarms are also always displayed as symbols in the relevant zone. The home view thus already provides information on the current zone status. In addition, the controller's status display (LED strip) changes colour in accordance with the message. Warnings are indicated by a yellow LED strip and alarms by a red LED strip.

Warning messages inform the system operator of potential problems. Production is continued, however. If an alarm message is issued, by contrast, the system operator is required to intervene. For critical alarms, a fault acknowledgement or system restart may be necessary. A detailed list of all the warnings and alarms is given in Chapter 5.3.2.2.4.

Procedure in the event of a fault (example: "defective triac" fault message):



Example 1 → To the fault handling via the navigation menu

	1. 	2. 	3. 
	Troubleshooting		

or



Example 2 → To the fault handling via a direct message in the affected zone

	1. 	2. 
	Troubleshooting	

	If alarms are issued for several zones in example 2, the messages for this zone will be displayed in filtered form. Press  for an overview of all the messages.
---	--

After navigating in  potential causes for the pending message appear. Each cause contains explanations which provide step-by-step support in eliminating the message.







	Fault rectification provides possible causes for the pending message. It can still, however, happen that an undocumented cause is responsible for the pending message.
---	--

The individual causes can be checked one after the other. Within a cause, it is also possible to use  and  to navigate back and forth between the instruction steps.

## Warnings and alarms

Symbol / Status	Description	Cause	Alarm socket
	Positive temperature deviation The actual temperature is currently above the set tolerance range.	Setting limit	Collective warning
	Negative temperature deviation The actual temperature is currently below the set tolerance range.	Setting limit	Collective warning
	Standby active Temperature deviations refer to the standby temperature	Standby is active	Collective warning
	Current deviation The present heating current is above the set tolerance value.	Tolerance value Heating fault Mains voltage fluctuation	Collective warning
	Output level deviation The mean output level is above the set tolerance value.	Overmolding Heating aging Defective parallel heating Heating fault Setting limit Triac	Collective warning
	Sensor voltage The voltage in the sensor line is inadmissibly high	Wiring error Connection to neighbouring zone Insulation damage	Collective warning
	Fault current Residual current flowing in the affected phase.	Moisture Insulation damage	Collective warning
	Sensor break The zone is not connected to the sensor.	Sensor connection in controller, connecting cable or mold	Collective warning or alarm
	or		
	Switch-off temperature The current temperature is above the maximum permitted temperature.	Setting limit Manual operation Wiring error	Collective alarm
	High temperature The current temperature is above the limit for an excessively high temperature.	Setting limit Manual operation Wiring error	Collective alarm
	Low temperature The current temperature is below the limit for an excessively low temperature.	Setting limit Manual operation Heating power Wiring error	Collective alarm
	<b>No connection to load</b> No current flows when the outputs are controlled with an output level > 0%	Connection to mold Cable/plug or heating unit defective Triac defective	Collective alarm
	<b>Sensor polarity</b> The sensor polarity has been reversed. Increasing temperatures are recorded as negative temperature values. Alarm only disappears if the connection cable will be disconnected and the reserved polarity will be changed.	Wiring error	Collective alarm
	Defective fuse No current flows despite the outputs being controlled	External fuse Internal fuse Insulation damage	Collective alarm



	Defective triac Current flows when the outputs are not being controlled.	Triac	Collective alarm
	Relay fault The output relay of the relevant zone is defective.	Internal hardware error	Collective alarm
	Load short circuit The current flowing is inadmissibly high.	Wiring error Insulation damage Heating	Collective alarm
	Internal bus error No communication to the affected power board.	Identical address assignment Communication disrupted Terminating impedance Defective hardware	Collective alarm
	System fault The power board has detected a hardware fault.	Internal hardware fault	Collective alarm
	Device group error Communication in the device group does not work properly.	Connection Error Configuration Error	Collective alarm

**5.3.2.3 Chart Recorder**



Operation > Chart Recorder

The chart recorder is used to analyze the control behavior of zones by displaying the profile over time of the process values for actual value, setpoint value and output level on a curve diagram. The curve is shown in the window with a black background. On the right of the screen are the arrow keys that can be used to select the zones for the display. Only one zone at a time is displayed in the curve window, with the three process values of actual value, setpoint value and output level. The process values to be displayed can be determined by clicking on the process value in question. If the process value is marked with a tick it will be displayed – if it has no tick, the process value will be hidden.

At the bottom of the screen there are additional buttons that can be used for the following settings:

15 min The chart recorder displays a time range of 15 minutes.

60 min The chart recorder displays a time range of 60 minutes.

4 h The chart recorder displays a time range of 4 hours.

 Zoom in  
The chart recorder's display range is reduced

 Zoom Out  
The chart recorder's display range is enlarged

 The display range can also be zoomed in/out by touching it. To do this, the desired range must be marked horizontally. The starting point must be indicated by touching the screen and swiping to the right. The display range is then marked in grey. As soon as the touch screen is no longer being touched, the marked area will be enlarged to fill the maximum displayable size in the display window.

 The display range will change so that the current values are shown in the right-hand section.



Screenshot  
The currently displayed chart is stored locally on the device.



Pressing this button opens a new window for filtering the zones to be displayed in the chart recorder.

### 5.3.2.4 Control



- 1.
- 2.

Operation > Control

The “Control” menu item contains settings that can be used to influence the control behavior of zones.

#### 5.3.2.4.1 Control dynamics

Value	Description		
Automatic Optimization	The automatic control optimization determines the P, I and D components of the controller automatically. This is only performed for zones in normal operation directly after the outputs are switched on and is marked "Optimized" in the status text below the zone designation. The zones to be automatically optimized when they are switched on can be determined by activating and deactivating the function. To do this, the zones should first be selected and the function then activated/deactivated with the corresponding buttons.	Standard:	automatic optimization active
P component	P component of the PID controller The output level is reduced linearly before attaining the setpoint value. Increasing the P band causes a slower transient response.	Min: Max: Standard:	0 % 100 % 5%
I component	I component of the PID controller. The reset time $T_N$ of the PID controller is specified in this setting. Increasing the reset time causes a slower transient response.	Min: Max: Standard:	0 s 999 s 80 s
D component	D component of the PID controller. The derivative time $T_V$ of the PID controller is specified in this setting. The derivative time is only effective with fast changes in the actual value. Increasing the derivative time causes a more dynamic transient response.	Min: Max: Standard:	0 s 999 s 16 s

The procedure for changing one of the PID parameters is as follows:

- First select the zones on the left whose parameters are to be changed
- Then, on the right side, select the desired parameter
- Open the box for entering the value with
- Enter the desired value in the input box
- Confirm with OK

#### 5.3.2.4.2 Heating signal

Clicking on the selection button opens the heating signal selection. A distinction is drawn in principle between pulse operation and phase control for the heating signal. Pulse operation and phase control are two different means of controlling the heaters.

Setting	Description
Pulsed Operation	During pulse operation, the heating output is switched on and off at full voltage in a specific ratio. The ratio of the time switched on to the time switched off is determined by the output level that is calculated by the controller. An output level of 25%, for example, means that the output is switched on for one time unit and then remains switched off for 3 time units. With a high output level, pulsed operation delivers better control behavior. The output switches the voltage in zero crossing mode, which causes less wear on the heating unit among other things. Factory setting: All zones in pulse operation
Phase Control	With phase control, the voltage at the heating output is kept proportional to the calculated output level. With a lower output level, phase control ensures better control behavior. Phase control, however, causes more wear than pulse operation. Factory setting: All zones in pulse operation
Mixed	This setting activates a combination of both operating modes, uniting the advantages of both. Factory setting: All zones in pulse operation

The procedure for changing the heating signal is as follows:

- First select the zones on the left whose heating signal is to be changed.
- Then, on the right side, select the desired heating signal
- Confirm with

### 5.3.2.4.3 Alerting

By clicking the selection button , you can set certain alarms. In general, no settings need to be made for these parameters. However, these settings can be useful for special applications.

Function	Description
Load Detection	<p>The load detection triggers an alarm if there is no current despite power output. This is used to detect whether a heater is correctly connected. A reliable load detection requires a current of at least 100 mA.</p> <p>The function can be deactivated in the selection "Load detection". The deactivated load detection is displayed by  in the zone selection.</p> <p>This function can only be deactivated for power cards with firmware 3.5 or higher. For power cards with firmware 3.4 or lower the input is blocked and is displayed with .</p>
Short heater Detection	<p>The short heater detection prevents the outputs from being switched on in the event of overload (&gt; 17 A), e.g. due to a short circuit. This prevents the fuse from being tripped and thus its replacement.</p> <p>The function can be deactivated in the selection "short heater detection". This allows the outputs to be switched on even at high currents (&gt;17 A). The deactivated overload detection is displayed by  in the zone selection.</p> <p>This function can only be deactivated for power cards with firmware 2.7 or higher. For power cards with firmware 2.6 or lower the input is blocked and is displayed with .</p> <div style="border: 1px solid black; padding: 5px; margin-top: 10px;"> <p>Attention! There is no longer an overload detection. This means that only the fuses are now used to protect against excessive currents.</p> </div>
Delay Fuse defective	A delay means that the fault is only signalled after it has been present for a set time. This allows the sensitivity to mains disturbances to be reduced.
Relay Error Detection	<p>The relay error triggers an alarm if the output relay cannot be opened or closed as expected. If the relay is mechanically damaged, it is not possible to safely switch the output</p> <p>This function can only be deactivated for power cards with firmware 4.2 or higher. For power cards with firmware 4.1 or lower the input is blocked and is displayed with .</p>
Triac Defective Detection	<p>The defective triac detection triggers an alarm if there is a current despite not power output. This prevents uncontrolled heating before a high temperature is signaled.</p> <div style="border: 1px solid black; padding: 5px; margin-top: 10px;"> <p>Attention! Triac monitoring is no longer performed. As a result, the system is only switched off if limit temperatures are exceeded. These must always be set specifically for the application.</p> </div>

### 5.3.2.5 Recipes

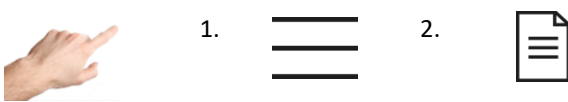

Operation > Recipes

Here, all parameters are displayed in a clear table, which can also be saved as a recipe. In addition, a previously saved recipe can be opened. The individual parameters are shown in the rows and assigned to a zone in the columns. Vertical scrolling takes you to further parameters, horizontal scrolling shows further zones. If a current parameter deviates from the value originally loaded via the recipe, the background of the parameter field is highlighted in yellow. Deviations that are not visible are indicated by yellow lines on the right scroll bar. Thus, it can be seen at a glance whether the recipe has been changed.

Function	Description
	Compare shows the comparison of the loaded recipe to the current settings. The value of the recipe is shown at the top, and the currently set value is shown at the bottom.
	Save allows overwriting the last loaded recipe with the current data.
	<b>Save As</b> allows you to save the current parameters under any name and to one of the following locations: local, USB, network drive.
	Under Open, the dialog for loading a recipe opens. When loading a recipe from the USB stick or network drive, the file is automatically copied to the local memory of the device. Recipe files can be renamed or deleted during the process.

### 5.3.3 Settings

All the device-specific settings are made under “Settings”. These are generally parameters that only need to be set once. They include language, temperature unit, date/time, timer, user administration and file management. Communication with external devices can also be specified. In addition, “Settings” contains all the topics of relevance for service and support, such as controller information, firmware update, service file, support and factory settings.

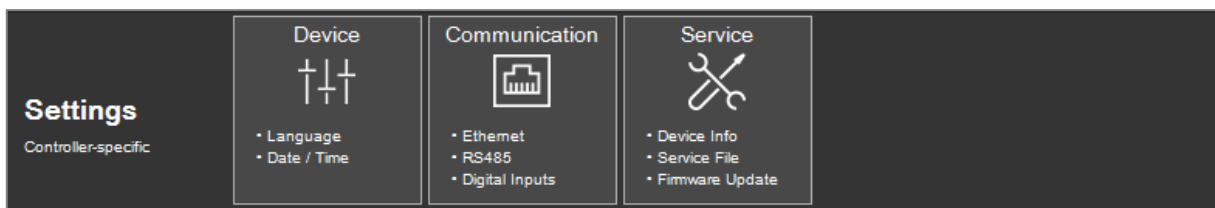

Figure 15 - Settings

#### 5.3.3.1 Device

##### 5.3.3.1.1 Language



Settings > Device > Language

The language of the user interface can be specified by selecting the corresponding flag. When the line containing the flag is pressed, this will be highlighted in colour. To adopt the selected language, the selection must be confirmed with the “Accept changes” button. All the texts will then be displayed in the new language during the runtime, and the selected language marked with a checkmark.

### 5.3.3.1.2 Temperature Unit

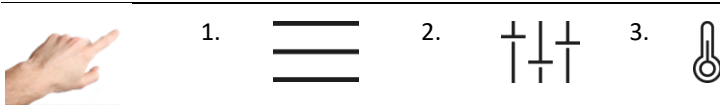

Settings > Device > Temperature Unit

Here the temperature display can be set to either °C (Celsius) or °F (Fahrenheit). When the corresponding line in the left window of the display is pressed, this will be highlighted in colour. To accept the changes, the selection must be confirmed with the “Accept changes” button. All displays during the runtime will then be shown in the selected temperature unit. The selected temperature unit will be marked with a tick.

### 5.3.3.1.3 Date / Time

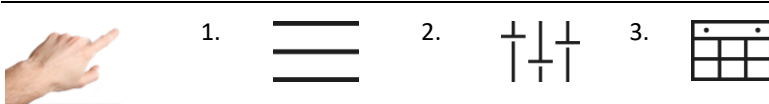

Settings > Device > Date / Time

On this page, the time for the controller can be precisely set with the year, month, day, hour and minute. A precise time is of particular importance for process values and events that are recorded with a time stamp.

To change the date or the time, it is necessary to use the

1. Arrow keys to set the corresponding value for the year, month, day, hour or minute.
2. Pressing the arrow key increases ( $\Delta$ ) / reduces ( $\nabla$ ) the value in the box highlighted in colour.
3. The changes are adopted by pressing the  $\checkmark$  button.

### 5.3.3.1.4 Heating Timer

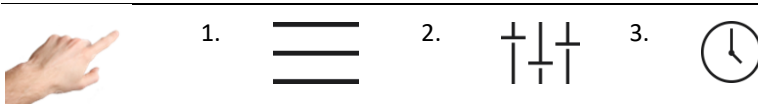

Settings > Device > Heating Timer

Using the timer, it is possible to have the outputs switched on and off automatically at certain times and on certain days.

The necessary settings may be found in the guided dialogue (1. 2. 3. 4.) The procedure is as follows:

1. First of all, the days on which automated switching on/off is required are activated. To do this, click on the box for the corresponding day of the week (Mon=Monday, Tue=Tuesday, etc.). The day of the week is marked with an  $\checkmark$  and, in the lower part of the window, the times for switching on/off are proposed. The tick indicates that automatic switching on/off will be performed on this day. By pressing this box once again, the tick will be hidden, deactivating automatic switching on/off.
2. To change the times for ON (switching on) and OFF (switching off), it is necessary to click in the relevant box. A further dialogue will open on the right side where the selected time can be set with the arrow keys. Each time the arrow key is pressed, the value in the box that is highlighted in colour will increase ( $\Delta$ ) / decrease ( $\nabla$ ).
3. The changes can be activated by pressing the “Accept changes” button  $\checkmark$ .
4. X closes the dialogue.

As soon as the timer is activated, an alarm clock symbol appears on the right of the menu bar next to the date and time.

### 5.3.3.1.5 User Management



- 1.
- 2.
- 3.

Settings > Device > User Management





The controller is protected against unauthorized settings by means of user levels. Each user level determines which changes are permitted. There are four user levels: Display, Operation, Configuration and Administration. If the current user level is setting, for example, then this is indicated in the menu bar with the lock. A separate password can be assigned to each user level.

	<p>Information:</p> <p>As the factory setting, all passwords are set to a value of 22</p>
--	---

To change a user level, it is sufficient to click the corresponding line in the available user levels. The box will be highlighted in colour. To accept the new user level, it is necessary to press the confirmation button. The user will then be prompted to enter the password for this or the next highest level. Clicking on “Login” opens the screen for entering the password, which is accepted with the Return key ↵. The higher the user level, the more changes are permitted. The following change options are allocated to the individual user levels:

User level	Change options
Display	<ul style="list-style-type: none"> <li>▪ No change options</li> <li>▪ Only navigation</li> </ul>
Operation	<ul style="list-style-type: none"> <li>▪ Setpoint values</li> <li>▪ Activation of boost</li> <li>▪ Activation of standby</li> <li>▪ Operating modes</li> <li>▪ Diagnosis</li> </ul> <p>Locked:</p> <ul style="list-style-type: none"> <li>▪ Parametrisation</li> <li>▪ Fault handling</li> <li>▪ Mold test</li> <li>▪ User administration</li> <li>▪ Factory setting</li> </ul>
Configuration	<ul style="list-style-type: none"> <li>▪ Setpoint values</li> <li>▪ Activation of boost</li> <li>▪ Activation of standby</li> <li>▪ Operating modes</li> <li>▪ Parametrisation</li> <li>▪ Mold test</li> <li>▪ Diagnostics and troubleshooting</li> <li>▪ Device group</li> </ul> <p>Locked:</p> <ul style="list-style-type: none"> <li>▪ User administration</li> <li>▪ Factory setting</li> </ul>
Administration	<ul style="list-style-type: none"> <li>▪ No restrictions</li> </ul>

The administrator can change and delete the passwords.





Function	Description
 Switch user level	Select the user level, select "Switch user level" and confirm with ✓. You will then be taken to the password entry screen if a higher user level has been selected.
 Change password	Select the user level for which the administrator wishes to change the password. This will be highlighted in colour. Then click on change password. A confirmation prompt appears, asking whether the password is really to be changed. This can be made to disappear either by clicking on X or by confirming the change. If it is confirmed, the new password must then be entered, which will be adopted by pressing return ↵. The new password must be entered a second time for verification. A brief message then appears at the bottom of the screen indicating that the password has been successfully changed.
 Deactivate password	First, the user level for which the administrator wishes to deactivate the password must be confirmed. This is then highlighted in colour. Next, click on deactivate password. A prompt appears, asking whether the password is really to be deactivated. This can be made to disappear either by clicking on X or by confirming the change. A brief message then appears at the bottom of the screen indicating that the password has been successfully deactivated.
 Forgot	By clicking on "Forgot password", information will appear on how a new password can be requested. Support will supply a one-day password for the Administration user level. The contact data for support can be found in the Service menu option (Settings > Service > Support)

### 5.3.3.1.6 File Management



Settings > Device > File Management

In the file management, files that are located locally on the controller can be copied or moved, e.g. to a USB stick, and files can be renamed or deleted. For this you only have to follow the guided dialog step by step.

Function	Description
 copy	This function copies a file to a new target directory. The local file is retained. To copy a file, select one or more files from the list of available files by clicking on the file name. The dialogue will then open on the right-hand side of the screen. Clicking on "Copy" and "Confirm selection" will activate the copying process. The dialogue for selecting the target directory will appear. The target directory can be changed by pressing the arrow. After selecting the desired target directory, the copy process can be confirmed ✓ or cancelled with X. Successful copying is indicated by a brief message at the bottom of the screen.
 move	This function is used to move a file to a new target directory, i.e. the file is then no longer in the original directory. One or more files must be selected from the list of available files by clicking on the file name. The dialogue will then open on the right-hand side of the screen. Clicking on "Move" and "Confirm selection" will activate the move. The dialogue for selecting the target directory will appear. The target directory can be changed by pressing the arrow. After selecting the desired target directory, the process can be confirmed ✓ or cancelled with X. If the files have been successfully moved, this will be indicated by a brief message at the bottom of the screen.
 rename	To rename a file, select one or more files from the list of available files by clicking on the file name. The dialogue will then open on the right-hand side of the screen. Clicking on "Rename" and "Confirm selection" will activate the dialogue for entering the new name, which is then adopted by pressing Return ↵. Successful renaming is indicated by a brief message at the bottom of the screen.
 delete	To delete a file, select one or more files from the list of available files by clicking on the file name. The dialogue will then open on the right-hand side of the screen. Clicking "Delete" and "Confirm selection" will delete the selected files.

### 5.3.3.1.7 Special Settings



- 1.
- 2.
- 3.

Settings > Device > Special Settings

Function	Description
Fair Mode	In exhibition mode, switching the outputs on and off requires a password. In normal operation, however, switching off is always possible for safety reasons. Factory setting: Inactive
Mouse cursor visible	The controller can also be operated with a connected USB mouse. For this purpose, the mouse cursor can be made visible here. Factory setting: Mouse cursor invisible
Display rotated	Rotates the display by 180°. This allows you to operate an appropriately prepared device with a display that can be folded down. This setting only affects the currently active display. Factory setting: not rotated

### 5.3.3.2 Communication

Communication contains settings and functions that are necessary for communicating, signalling with and for external control by e. g. an injection moulding machine.

#### 5.3.3.2.1 Ethernet



- 1.
- 2.
- 3.

Settings > Communication > Ethernet

Ethernet is the network interface of the controller. The menu shows the parameters of the Ethernet interface, such as IP address, which are necessary for data exchange with the controller via the FE3 protocol or OPC UA (Euromap 82.2).

#### 5.3.3.2.2 Adresses



- 1.
- 2.
- 3.
- 4.

Settings > Communication > Ethernet > Adresses



Function	Description
IP-Address	Shows the current IP address of the controller. Setting options: Automatic → With this setting, the device expects an automatic assignment of the IP address by a so-called DHCP server. Manual → With this setting, the IP address can be entered manually. Factory setting: Automatic
Subnet Mask	Setting options: Automatic → With this setting, the device expects an automatic assignment of the IP address by a so-called DHCP server. Manual → With this setting, the IP address can be entered manually. Factory setting: Automatic
Default Gateway	Setting options: Automatic → With this setting, the device expects an automatic assignment of the IP address by a so-called DHCP server. Manual → With this setting, the IP address can be entered manually. Factory setting: Automatic

### 5.3.3.2.3 Network Drive



- 1.
- 2.
- 3.
- 4.

Settings > Communication > Ethernet > Network Drive

Function	Description
Server name	The connection to a network drive can be set up here. This allows controller specific files to be saved and loaded. The drive has the format \\<server name>\<share name>. Specify the server name here without using backslashes. IP addresses are not supported.
Share name	See server name
User name	If access to the network drive requires authentication, the user name can be stored here. Access data is stored on the device, but cannot be exported, e.g. via service file.
Password	See user name

### 5.3.3.2.4 VNC



- 1.
- 2.
- 3.
- 4.

Settings > Communication > Ethernet > VNC

Function	Description
<b>Password</b>	Access to the device via VNC is protected with a password that can be changed here. An empty password or a deactivation of the password protection is not possible. Factory setting: 123456

### 5.3.3.2.5 Protocols



- 1.
- 2.
- 3.
- 4.

Settings > Communication > Ethernet > Protocols

Function	Description
OPC UA (OPC40082-2) TCP4840	In accordance with Euromap 82.2, status information, general information and determined process data are provided by the T-Fflow hot runner controller. In addition, hot runner controllers can be parameterized by the injection molding machine or other OPC UA capable devices. In addition to operating modes and setpoints, alarm limits and the heating process can also be adjusted, so that Euromap 82.2 makes almost all process-relevant parameters adjustable via OPC UA capable devices. Therefore, as long as an injection molding machine has Euromap 82.2 communication, MCS hot runner controllers with firmware version 4.2 or higher can be operated and read out by injection molding machines true to specification. For all controllers with older firmware, a free update is available.
Feller FE3BUS UDP8070	Proprietary ASCII protocol that almost completely maps the controller functions - A protocol specification is available on request.
FANUC Modbus TCP503	Protocol for coupling the controller to a FANUC injection molding machine, via Modbus TCP. The protocol can be used to query the most important process values (actual values, alarms, power, current) and to set the setpoints and alarm limits.
VNC TCP5900	The VNC protocol can be used to mirror the entire operator interface. Injection molding machines from several manufacturers have this function, which allows the controller to be conveniently operated from the operating terminal of the injection molding machine.

### 5.3.3.2.6 Device Group



- 1.
- 2.
- 3.

Settings > Communication > Device Group

With the device group, several controllers can be connected to form a single unit. This allows all connected devices to be operated from one controller, so that several individual devices act like a single controller with a correspondingly higher number of zones.

As a prerequisite, the devices must be connected via Ethernet. This may also require further peripherals such as a separate operating unit or a network switch. In this way, applications with up to 480 zones can be realized.

#### Communication channel in the device group (optional setting)





	Note	The communication of the devices in the group works via UDP multi-cast address.
--	------	---

The communication channel defines the multicast address. The address is:  
 "224.0.[Communication channel setting].0"

Function	Description
<b>Communication Channel</b>	If there are several device groups in the same network, they must communicate on different communication channels to ensure error-free operation. For this purpose, this channel must be set to the identical address on all participants of a device network before the network is started.

Boundaries 0...255  
Factory setting: 1; if set to value "0", communication is disabled

**Start device group**

1. Press the "Start device group"  button. Then, according to the user level, the password must be entered.
2. Next, a list of all devices in the network is displayed. In addition to the serial number, the zone number of the respective controller is also displayed. The devices that are to be used for the group must be selected accordingly. Selected devices in this list show this via a circulating LED band.
3. The selection must then be confirmed via .
4. Subsequently, the device group must be confirmed by password at all selected participants.
5. In the subsequently displayed dialog on the operating unit, the order of the controllers can optionally be adjusted. This allows the individual controllers to be arranged using the arrow keys so that zone numbers are lined up one after the other accordingly. To conclude, confirm again with .
6. The operating unit now displays all zones of the controllers involved in the device group. The parameterization of all zones is now only carried out via this display.
7. The operating displays of the connected devices can only be parameterized to a limited extent. Functions such as file management, the creation of service files or the configuration of interfaces that are device-specific can still be set here. By pressing , the LED display of the operating unit flashes, so that it makes it easy to find out the operating unit.

**Cancel device group**

The device group can be deactivated at the operating unit via . Subsequently, all controllers that were previously only operable as a group can be used again as a single unit.

**Status messages in the group**

When the device group is active, the status of all nodes is always displayed on the configuration page. The following states can occur:

Connection status	Description	Solution approach
OK	Connected	
Connection error	Connection to the respective subscriber is interrupted	Check if device is not switched on, network cable not plugged in or defective, network switch switched off or defective
Incompatible	Firmware version of the control unit is not compatible with the firmware of the paired controller	Update firmware of the affected controller
Configuration error	Connected controller operates as an individual controller, although it should be part of the device group	Deactivate device group on operating unit and restart

**5.3.3.2.7 RS485**

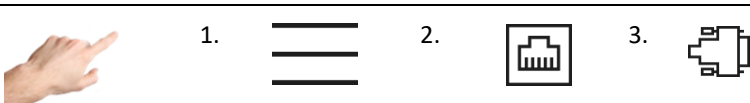

Settings > Communication > RS485

RS485 is the serial interface of the controller. This menu item contains the following setting options:



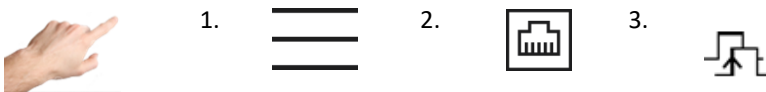

Function	Description
RS485: Protocol	<p>Defines the protocol type to be used for communication via RS485.</p> <p>Setting options:            FE3BUS protocol for seamless logging of all process values and operation of all available parameters.            ARBURG EUROMAP 17 → Protocol for coupling the controller to an ARBURG injection molding machine, which in turn must have a serial interface to a hot runner controller. Some important process values (actual values, alarms) can be queried via a restricted EUROMAP17 protocol and the setpoints can be operated. This is usually done with a maximum of 9600 baud.            FANUC Modbus → Protocol for coupling the controller to a FANUC injection molding machine, which in turn must have a serial interface to a hot runner controller. Via the Modbus protocol, the most important process values (actual values, alarms, power and current) can be queried and the setpoints and alarm limits set.            ENGEL / HB-Therm → Protocol for coupling the controller to an ENGEL injection molding machine, which in turn must have a serial interface to a temperature control unit. This can be used to set setpoints and to query actual values and alarms.            Factory setting: FE3BUS</p>
Baud Rate	<p>This parameter sets the baud rate. The baud rate must be identical for the controller and the device to be connected, otherwise interference-free communication cannot be guaranteed.</p> <p>Setting options:            9600; 19200; 38400; 57600; 115000            Factory setting: 19200</p>
Address	<p>To address the controller it is necessary to assign an address. To ensure trouble-free communication, the controller and the device to be connected may have different addresses.</p> <p>Setting limit: 1 ... 30            Factory setting: 1</p>

### 5.3.3.2.8 Digital Inputs



Settings > Communication > Digital Inputs

The digital inputs of the controller can, for example, be controlled by a PLC with a 24 VDC signal. For each function, a distinction can be made between the following five control modes:

Control mode	Description
Input inactive	The input is inactive. Incoming signals are ignored and are not logged in the event list.
Level-controlled high-active 	As long as a signal (high level) is present at the digital input, the function remains activated. It cannot be deactivated via the user interface.
Level-controlled low-active 	As long as a signal (high level) is present at the digital input, the function remains deactivated. It cannot be activated via the user interface.
Edge-controlled high-active 	With every change at the digital input from 0V to signal (High) the function is switched over. This can be realized by a pulse of at least 100 ms. Thus the function can also be changed at any time via the user interface.
Edge-controlled low-active 	With every change at the digital input from signal (High) to 0V the function is switched over. This can be realized by a pulse of at least 100 ms. Thus the function can also be changed at any time via the user interface.

The following functions can be performed by the control inputs:

Function	Description
Boost (Digit-In, Pin 1)	The input allows machine controlled boosting. The function affects all zones that have a set boost duration and a boost offset greater than zero. Factory setting: Input inactive
Outputs On/Off (Digit-In, Pin 2)	The input permits machine-controlled switching of the outputs. Thus the heating process can be started and stopped by the digital input. Factory setting: Input inactive
Release Outputs (Digit-In, Pin 3)	The input permits machine-controlled output release. The controller outputs can be switched independently, but the controller only outputs power if the outputs are switched on and enabled via this digital input. Factory setting: Input inactive
Standby (Digit_In, Pin 4)	The input permits machine-controlled lowering to standby temperature. Factory setting: Level-controlled, high-active
Additional Heaters On/Off Digit-In, Pin 9	The input allows machine-controlled switching of additional heaters. Zones of group 8 are switched to control mode – or switched off. Therefore, in addition to this setting, the corresponding zones must be assigned to group 8 under “Quick start”(chapter 5.3.1.1.1). If zones are assigned to this group and the function is activated via the control input, the corresponding zones switch between “control mode” and “zone inactive”. Factory setting: Input inactive

### 5.3.3.2.9 Notification Contacts

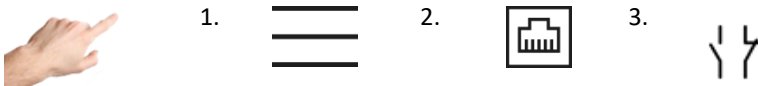

Settings > Communication > Notification Contacts

The notification contacts are potential-free led out to the signaling socket on the back of the controller. Warnings and alarms can thus be communicated to an injection molding system as a collective signal. Each contact can be configured as follows:

Configuration	Description
NC contact (fail-safe) 	As a normally closed (NC) contact, the contact is normally closed and opens as soon as an alarm or warning is present. This behavior is fail safe, since each interruption of the connection also opens the circuit.
NO contact 	As a normally open (NO) contact, the contact is normally open and closes as soon as an alarm or warning is present.

Depending on the configurations above, the following contacts can be set:

Function	Description
Contact 1: Warnings	The notification contact 1 switches when a warning is signaled at at least one zone or when the LED band lights up yellow, e.g. in case of temperature deviation. Factory setting: Break contact (fail safe – NC, normally closed)
Contact 2: Alarms	The notification contact 2 switches when an alarm is signaled at at least one zone or the LED strip lights up red, e.g. in the event of a sensor break. Factory setting: Break contact (fail safe – NC, normally closed)
Contact 3: (configurable)	The notification contact 3 is configurable and switches according to the selected function. Factory setting: Normally open contact (NO, normally open). Alarms (default): The signaling contact switches when an alarm is signaled in at least one zone or the LED band lights up red, e.g. in the event of a sensor break. Boost: The signal contact switches when at least one zone is booting. The system is only switched off when all zones no longer report a positive temperature deviation after the boost.

5.3.3.3 Service



Settings > Device > Service

Service contains information and functions that are useful in the event of service case.

Function	Description
Device info	Device info lists the most important information on the device and also on the current software versions of the installed hardware.
Firmware update	<p>The firmware updates for the control unit and power unit in the controller can be carried out here. The update can be installed via a flash drive. A flash drive with the update program must be connected up for updates to the control device. The update process starts automatically.</p> <p>For updates of the power boards, a flash drive with the firmware must be inserted in the main directory and the device restarted. Then follow the instructions on the starting page.</p> <p>Once the update process is completed, the controller will start again.</p>
Service File	<p>The service file contains technical data that are useful for support when analysing errors.</p> <p>A click on the icon in the left-hand side of the screen starts the saving process. The dialogue for selecting the target directory will appear. The target directory can be changed by pressing the arrow. After selecting the desired target directory, the process can be confirmed by pressing the tick, or cancelled with X. Successful compilation of the service file is indicated by a brief message at the bottom of the screen.</p>
Support	<p>The support page contains the main contact data for support. A one-day password can also be requested here if the password has been forgotten. (See also: Settings &gt; Device &gt; User management)The login button for service personnel releases further details that are only available to service employees.</p>
Factory Settings	<p>The controller can be reset using two different methods. If "Load default parameters" is selected, all the parameters will be reset to their default values. All files on the device, such as recipe files, protocols and screenshots are retained.</p> <p>If "Reset to factory setting" is selected, all the parameters will be reset to their default values and all files on the device will be deleted. This requires the user level "Administration" or higher.</p> <p>In both cases, a dialog will appear for entering the corresponding password.</p>

5.4 Index

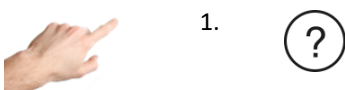

Index

The index contains all the important keywords with a brief explanation and makes it possible to navigate, with a single click, to the page on which the settings are made.

There are two ways to find the term being searched for. The alphabetical list can be scrolled by pressing the rectangle at the right edge of the screen and moving it up or down. Or, the first letter of the term being searched can be clicked beneath the menu bar (A to Z).

If the terms marked in colour are clicked, these will lead directly to the screen page where the settings for this term are made. Terms in white are not navigable but serve solely as explanations.

5.5 Switch all outputs on and off



In the menu bar

A longer press on the arrow button will start the heating process by activating the controller outputs. Zones in the “Inactive mode” operating mode will remain switched off. When the outputs are activated, the internal relays will close and the output level will be output at the corresponding contacts.



In the menu bar

After activating the On/Off button, the color of the icon and the background changes. This indicates that the outputs are active. The On/Off button must be pressed to deactivate the outputs. The icon appears again without a coloured background.

### 5.6 Standby operation



In the menu bar

When the outputs are switched on (see above), pressing the standby button for a longer period of time will initiate the temperature reduction mode in which the temperature of all zones in control mode are reduced to the specified standby temperature.

“Standby” is displayed in the zone designation and the setpoint value for standby appears in the setpoint display.

The value of the standby temperature can be set individually in Setup > Quick start > Setpoint values.



In the menu bar

During standby, the standby button changes and is displayed with a colored background. If you press it again, the standby mode is cancelled and the pause button reappears with a white background.

### 5.7 Boost function



In the menu bar

When the outputs are switched on (see above), pressing the Boost button will start the boost function. Zones with set parameters Boost Offset and Boost Duration increase their setpoint for a defined time. This function works on all active zones in the control mode.

Boost" is displayed in the zone designation and the setpoint value including the set Boost Offset parameter appears in the setpoint value display.

The value of the Boost Offset and Boost Duration can be set individually in the settings Setup > Quick start > Setpoints.



In the menu bar

During boosting, the boost button is displayed with a colored background. The background shows a color gradient according to the set Boost Duration. When the button is pressed again, the boost function is terminated and the boost button reappears with a white background if it has not been pressed.

## 6 Technical data

Technical Data	
Display 6 to 36 zones tabletop unit	Integrated 7" touchscreen, resistive Optional: external 15" touch monitor (capacitive)
Display 42 to 120 zones tower unit	Integrated 10" touch screen (capacitive) or External 19" touch monitor
Housing material	Galvanised steel
Protection type	IP 20
Operation temperature	0...50°C
Humidity	0...90% rel. humidity, no condensation
Storage temperature	-25...+75 °C
Supply voltage	3x 400 V AC, N, PE
Switchable to	3x 230 V AC, PE
Tolerance	+ 10% / -15%
Power consumption (idle)	7 W + 5 W per power board
Internal control voltage	+24VDC
Protection Power supply unit	1 x 2,5A medium delay (5 x 20mm)
Thermocouple	Fe-CuNi (TYPE J) 0..830° switchable to: NiCr-Ni (TYPE K) 0..830°
Cold junction compensation	Integrated
Resolution (accuracy with calibrated characteristic of the thermocouple sensor)	+/- 0.1K (°C and °F)
Accuracy (tolerance of the compensation line)	+/- 0,25K
Full Scale Error	+/- 0,3%
Control accuracy	< 0,1 K (°C and °F)
Load outputs per zone	Bistable, electrically insulated 1x heating, 230V AC switching
Control time (phase angle /pulse package)	10 ms at 50 Hz – 8.3 ms at 60 Hz
Current per zone	max. 16 A with 80% switch-on duration per zone
Caution: observe the total load capacity of the electrical connection cable	
Signal shape	Pulse operation/phase control (automatic or manual selection)
Protection load outputs Only use these fuse types!	2-pole; 6.3 x 32 mm Internal: SIBA TYPE 16A T External SIBA TYPE 16A GRL
3x relay contact	Potential-free for max. 250 VAC
Maximum current	3 A for $\cos\varphi = 1$ ; 2A for $\cos\varphi = 0.5$
Digital inputs	
Insulated, potential-free	16 – 30 V DC
Ethernet	CAT 5
RS485	D-SUB 9-pole
USB	USB 2.0 Standard



## 7 Dimensions

### 7.1 12 zone controller

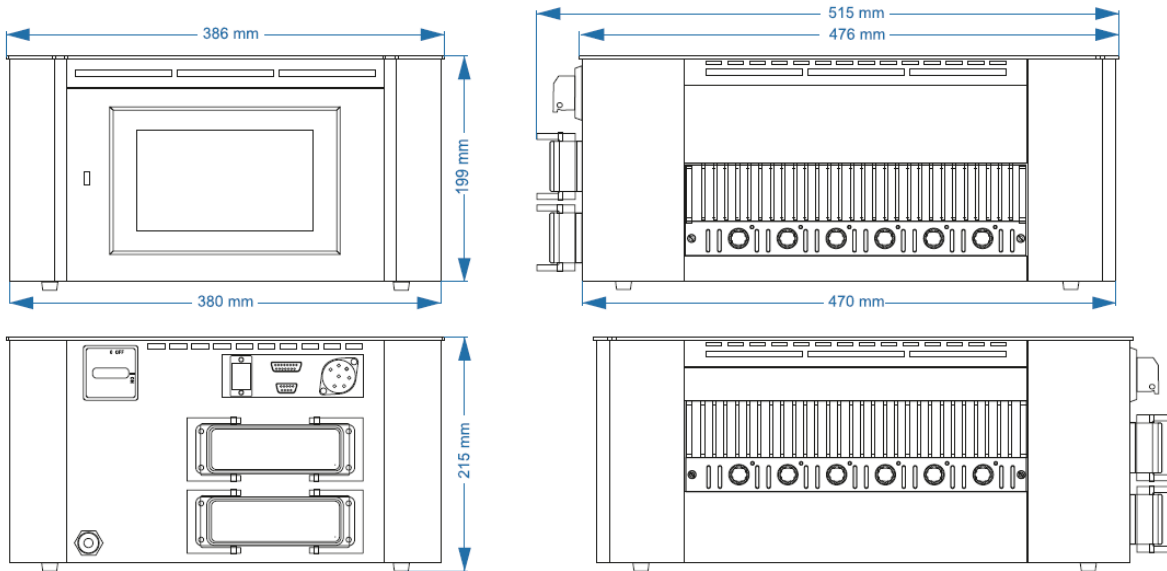

### 7.2 24 zone controller

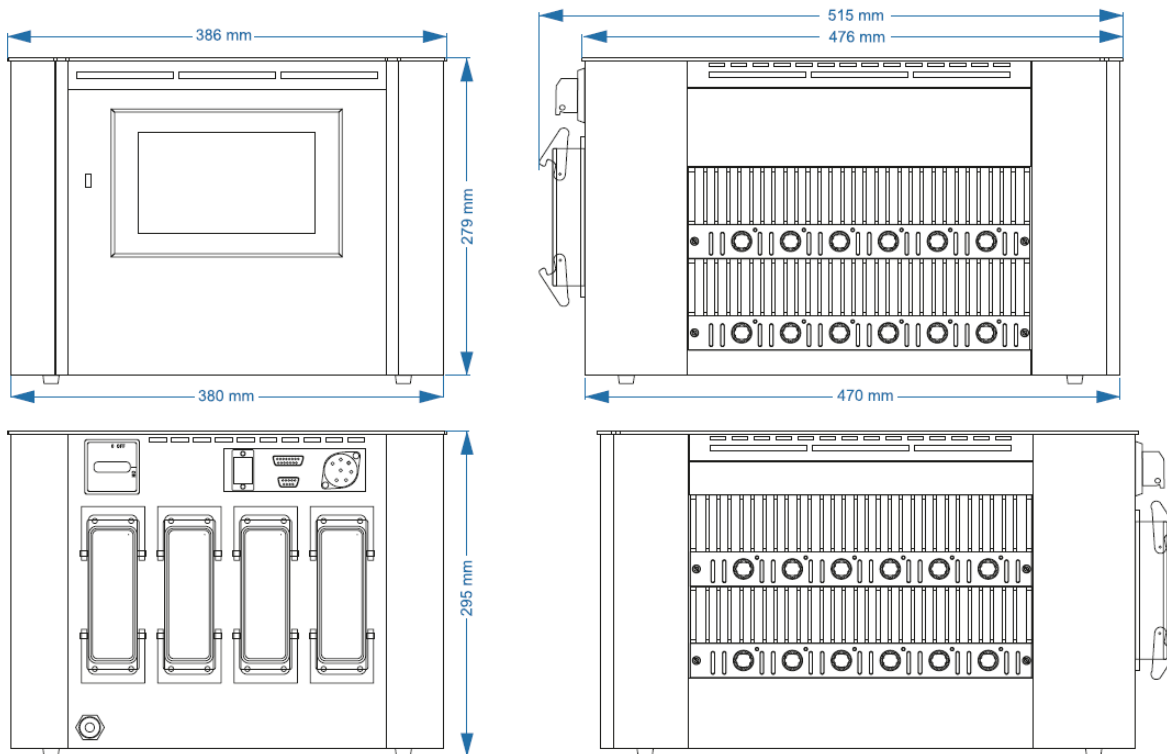

**7.3 36 zone controller**

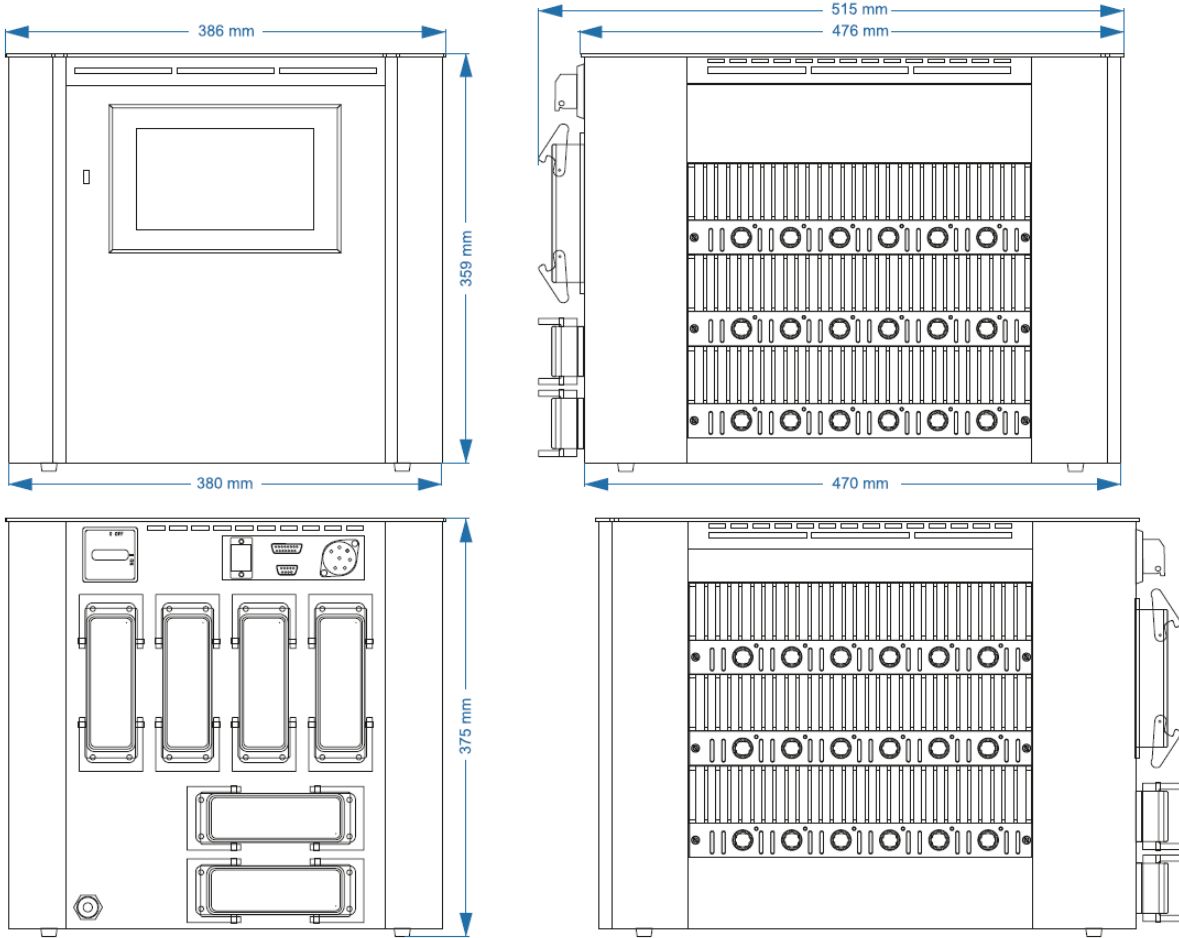

7.4 120 zone controller

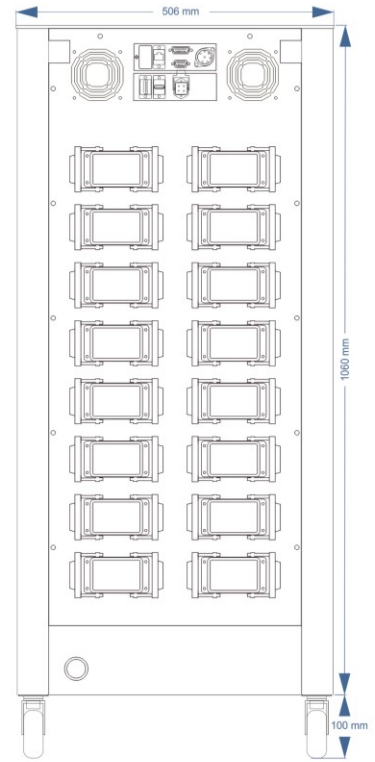
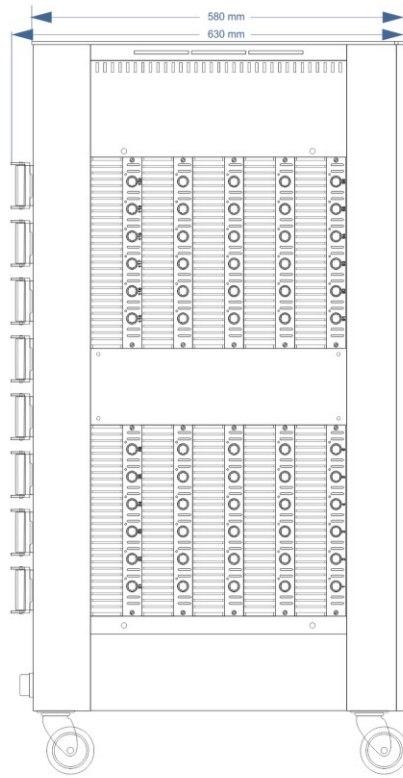
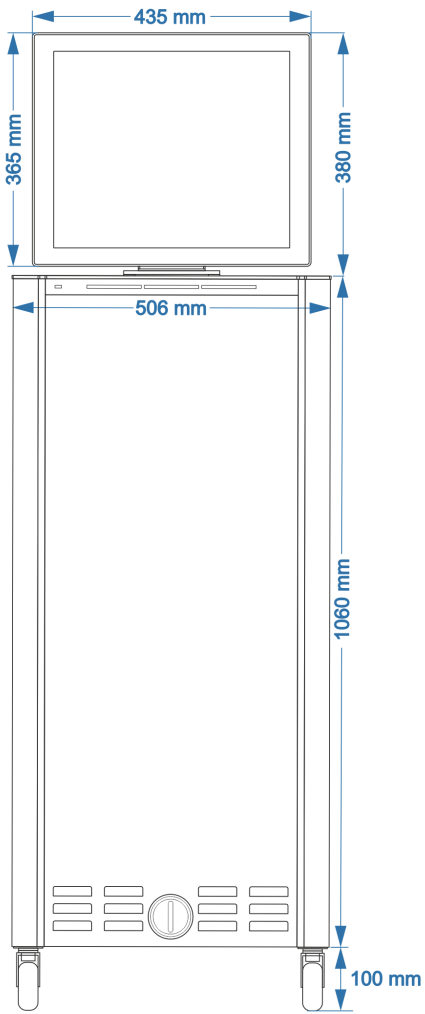

## 8 Appendix

### 8.1 Terminal bridges for the star-delta supply

#### 8.1.1 Terminal bridges in star supply network

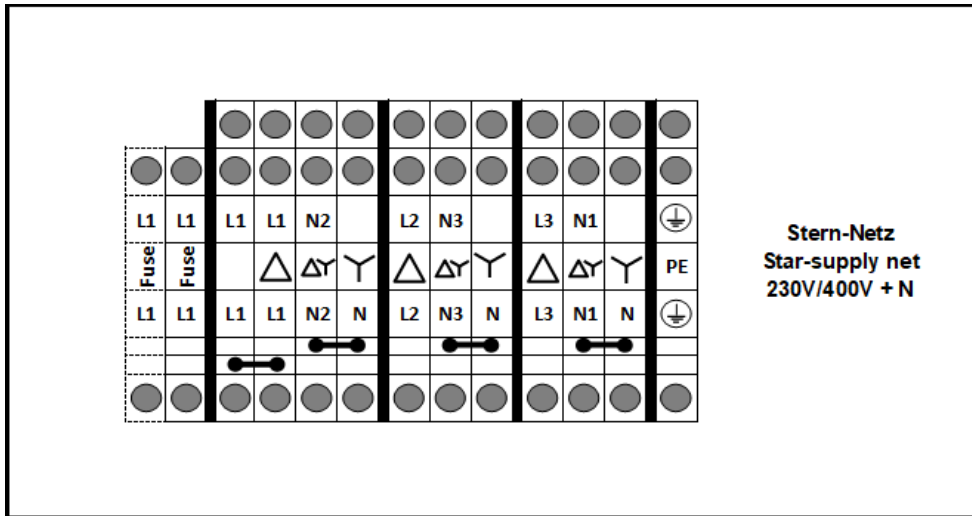

Figure 16 - Star supply

#### 8.1.2 Terminal bridges in delta supply network

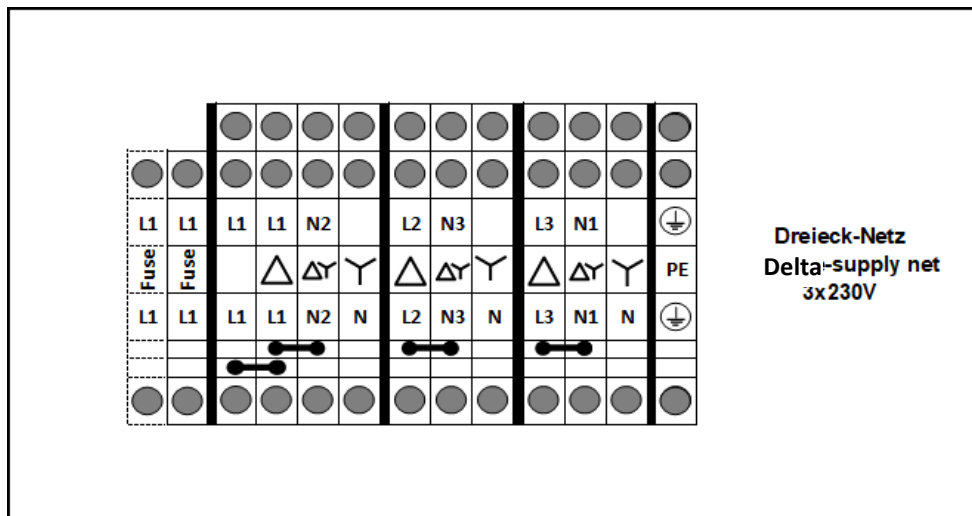
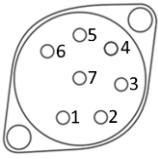

Figure 17 – Delta supply

### 8.2 Pin assignment alarm/ notification socket



Alarm/ Notification socket	Function	
1 + 3	Collective warning	Break contact (fail-safe)
4 + 5	Collective alarm	Break contact (fail-safe)
2 + 6	Collective alarm	Make contact

### 8.3 Pin assignment digital inputs

Reading direction →\*

Input 1-8

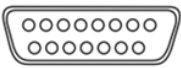

Input 9-15

Digital input	Function	
1	Boost	+24VDC
2	Outputs On/Off	+24VDC
3	Release Outputs	+24VDC
4	Standby	+24VDC
5	No function	
6 – 8	GND	0VDC
9	Additional Heaters On/Off	+24V
10	Auto-Standby	+24V
11 – 12	Without function	
13 – 15	GND	0VDC

\* The individual pins are also marked on the plug.

### 8.4 Pin assignment RS485

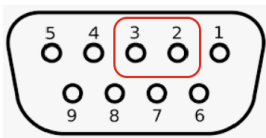

RS485	Function
2	Rx/Tx+
3	Rx/Tx-

## 9 Index

- Additional Heaters 45
- Administration 38
- Alarm socket 53
- Alarms 32
- Alerting 35
- Boost 18, 30, 45
- Broken sensor 19
- BSB 25
- Chart Recorder 33
- Communication 40
- Communication Channel 42
- Connections 8
- Control dynamics 34
- Control mode 17
- Control quality 27
- Cooling limit 21
- Copy file 39
- Current deviation 32
- D component 34
- Date / Time 37
- Defective fuse 32
- Defective triac 33
- Delay Fuse defective 35
- Delete file 39
- Delta supply 52
- Deviation, graphic 27
- Diagnostics 30
- Digital inputs 9
- Digital Inputs 44, 53
- Dimension 49
- Display 8, 26
- Ethernet 40
- Ethernet connection 8
- Euromap 82.2 40
- Events 31
- External touch monitor 9
- Fault current 32
- Fault handling 30, 31, 38
- File Management 39
- Groups 13, 16, 18
- Heating 21
- Heating current 20
- Heating signal 34
- Heating timer 37
- High temperature limit 19
- I component 34
- Index 46
- Internal bus error 33
- Internal setpoint 27
- Language 36
- LED-Band 8
- Load Detection 35
- Load short circuit 33
- Low temperature 32
- Low temperature limit 19
- Main switch 10
- Main view 25
- Mains Voltage 25
- Manual mode 17
- Mean output level 27
- Mold check 22
- Mold Check Timeout 23
- Monitoring 18
- Monitoring mode 17
- Move file 39
- Navigation bar 11, 12
- Navigation menu 14
- Negative temperature deviation 32
- Notification contacts 9
- Notification Contacts 45
- Offset 19
- OPC UA 40
- Operating mode 16
- Operation 11, 17, 25
- Optimizing 26
- Output level 20, 24
- Output level deviation 32
- P component 34
- Positive temperature deviation 32
- Production cycle 21
- Quick start 11, 15
- Ramp gradient 22
- Recipe 11
- Reference Mode 17
- Reference zone 19
- Relay Error Detection 35
- Relay fault 33
- Rename file 39
- RS485 43
- Safety instructions 5
- Sensor break 32
- Sensor polarity** 32
- Sensor type 24
- Sensor voltage 32
- Sequential heating priority 21
- Service 46
- Setpoint value 17
- Settings 36
- Setup 15
- Short heater Detection 35
- Softstart 22
- Special Settings 40
- Standby 18, 45
- Star supply 52
- Star-Delta 52
- Start menu 11
- Start screen 11
- Structure 6
- Switch-off temperature 32
- System fault 33

Technical data 48  
Temperature deviation 27  
Temperature difference 21  
Temperature Unit 37  
Thermodynamic Analysis 22  
Tolerance range 19  
Triac Defective Detection 35  
Troubleshooting 31, 38

Type plate 9  
Update 46  
USB connection 8  
User management 38  
Warnings 32  
Wiring check 22  
Zone designation 16  
Zone inactive 17



***Turn To The Industry Experts***

34500 Doreka Drive, Fraser, MI 48026

[sales@pcs-company.com](mailto:sales@pcs-company.com)

1-800-521-0546